

5. Alianza CIER Norte - Cartagena

* Space information of Universidad de Cartagena

RIC	Office	Building Name	Floor	Size(W X D X H)	Remark
Alianza CIER Norte (Cartagena)	RIC Operation Office	Multimedia Building	2 nd Floor	6.6 X 6.0 X 2.4	
	Multimedia Studio	Multimedia Building	4 th Floor	10 X 12 X 3.0	
	Content Development and Research Office	Multimedia Building	1 st Floor	10 X 5.5 X 2.4	
	Multimedia Classroom #1	Multimedia Building	3 rd Floor	10 X 6.0 X 2.4	
	Multimedia Classroom #2	Multimedia Building	3 rd Floor	10 X 6.0 X 2.4	
	General Classroom #1	Multimedia Building	4 th Floor	9.4 X 5.0 X 2.6	
	General Classroom #2	Multimedia Building	4 th Floor	9.4 X 5.0 X 2.6	

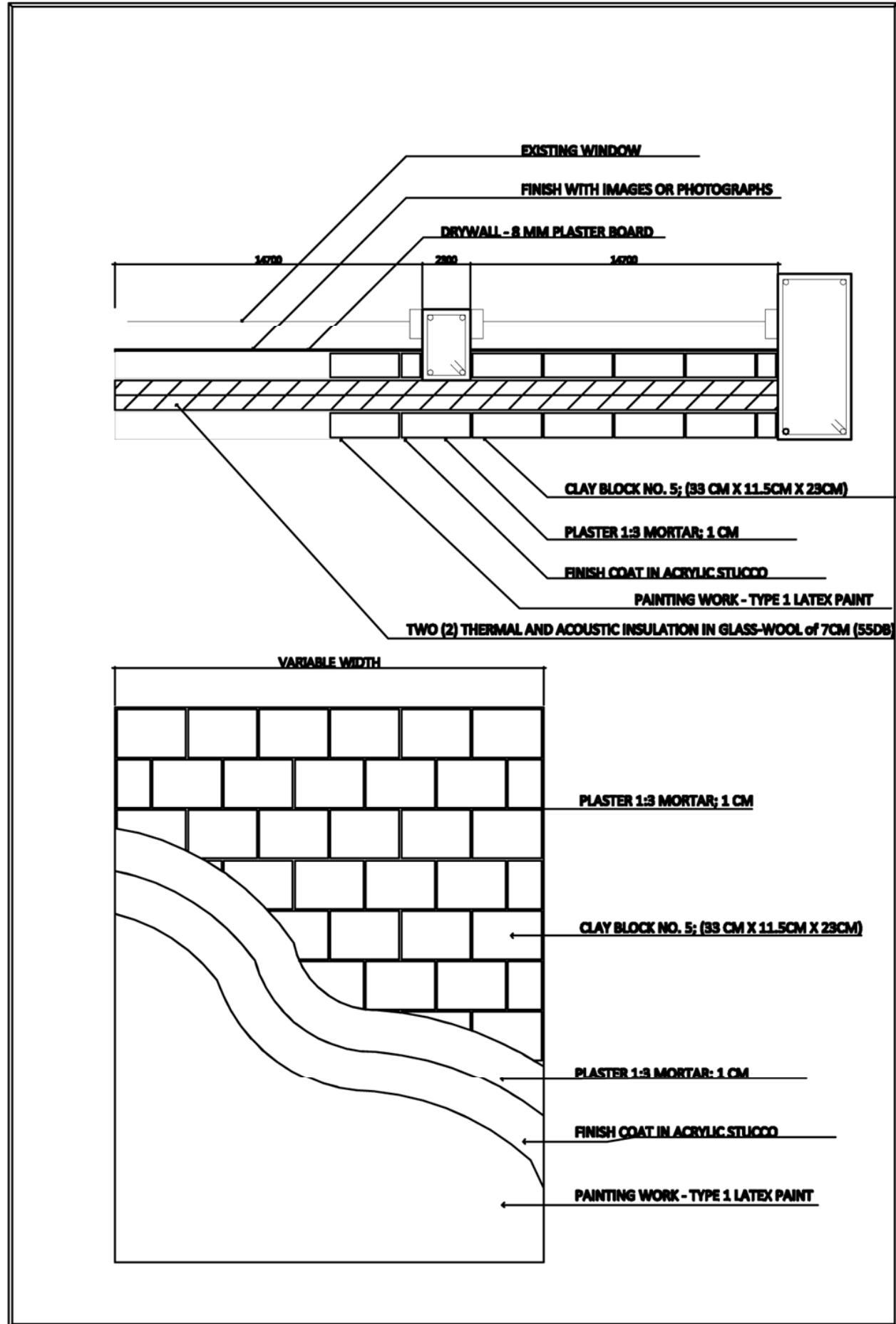

DET. 3

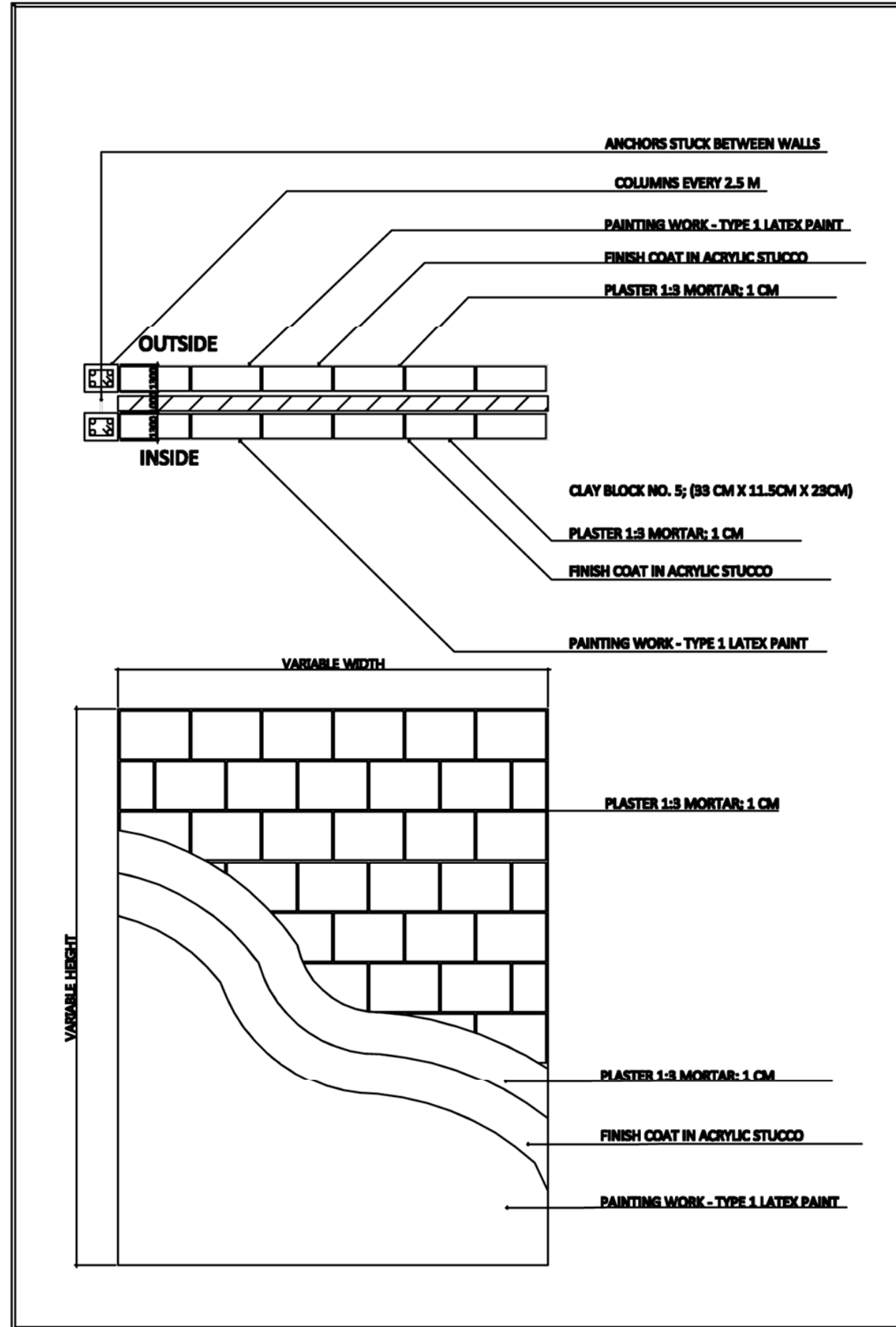

DET. 4

NOTE

DATE

DRAWN BY

DESIGNED BY

CHECKED BY

APPROVED BY

PROJECT TITLE

DRAWN TITLE

SCALE

SCALE
1/25

1

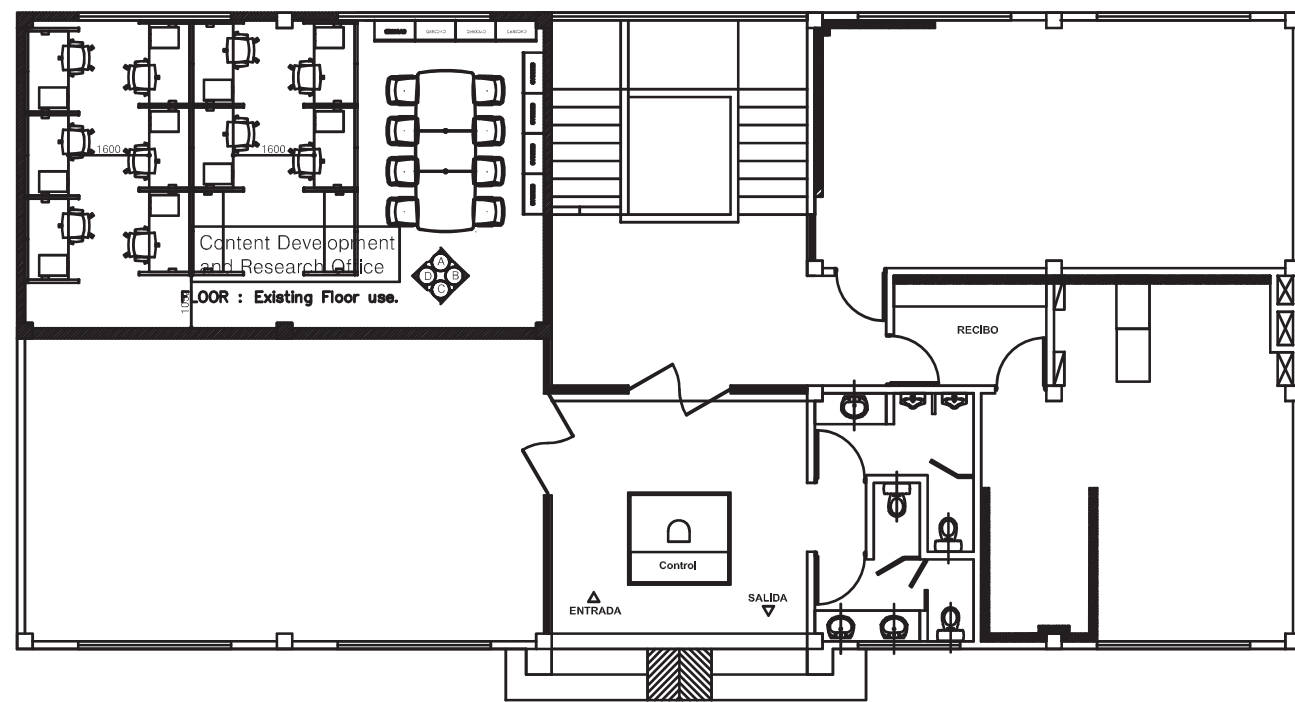

NOTE

DATE

DRAWN BY

DESIGNED BY

CHECKED BY

APPROVED BY

PROJECT TITLE

DRAWN TITLE

SCALE

SHEET NO.
DRAWN NO.

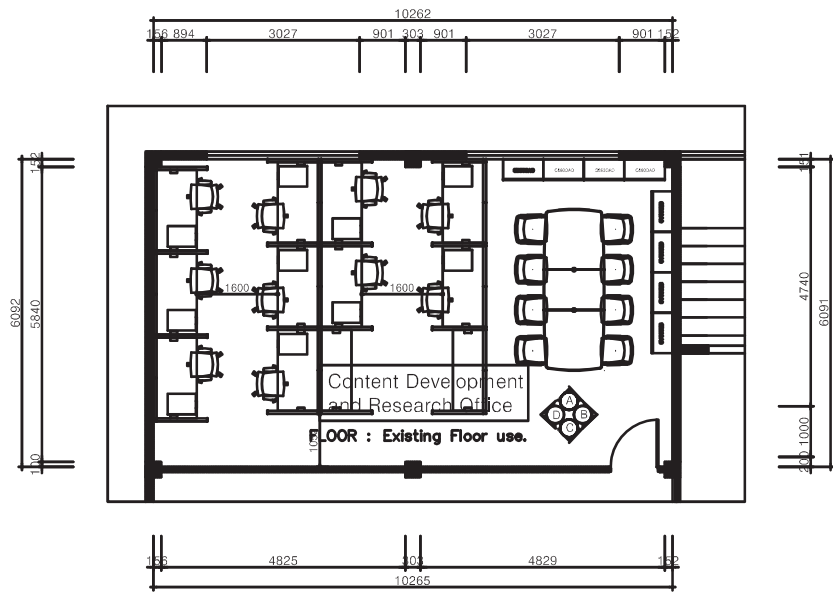

FLOOR PLAN

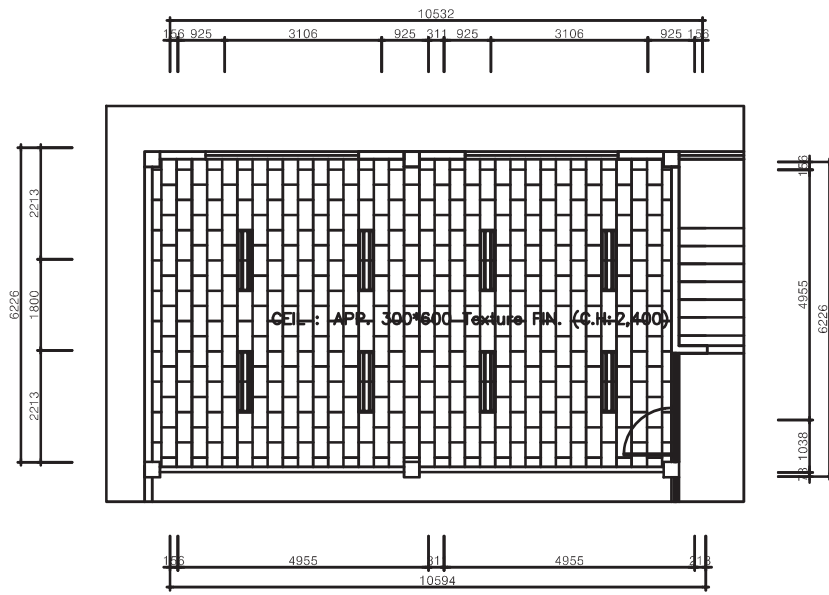

CEILING PLAN

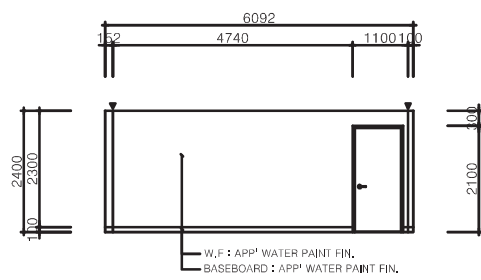
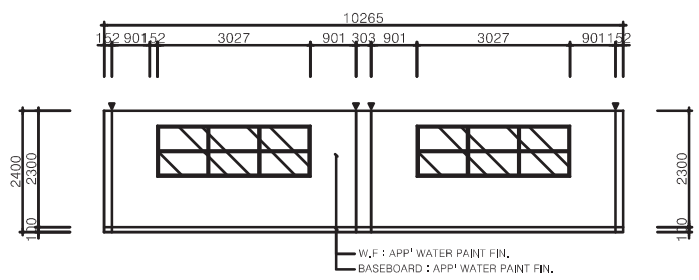

ELEVATION_A/B

ELEVATION_C/D

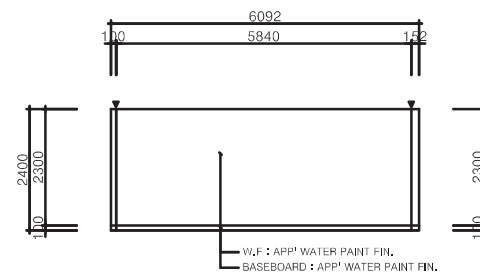
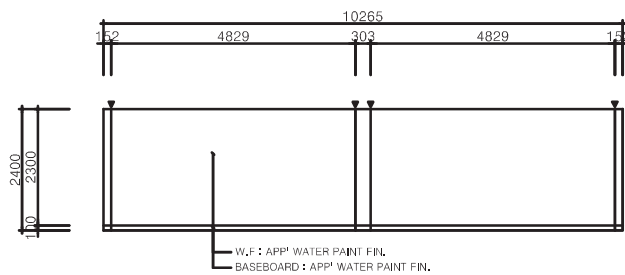

NOTE

DATE

DRAWN BY

DESIGNED BY

CHECKED BY

APPROVED BY

PROJECT TITLE

DRAWN TITLE

SCALE

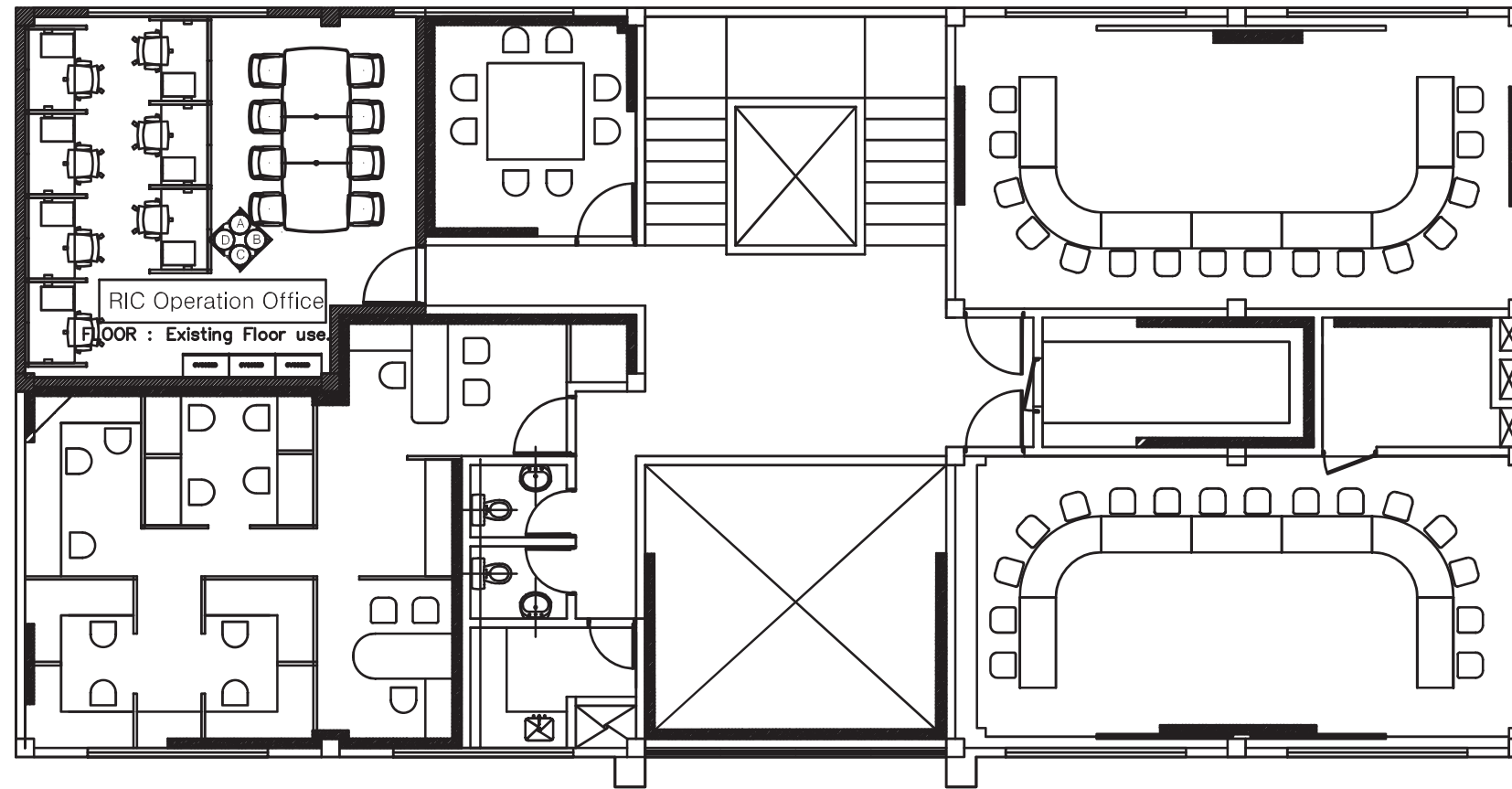

NOTE

DATE

DRAWN BY

DESIGNED BY

CHECKED BY

APPROVED BY

PROJECT TITLE

DRAWN TITLE

SCALE

SHEET NO.
DRAWN NO.

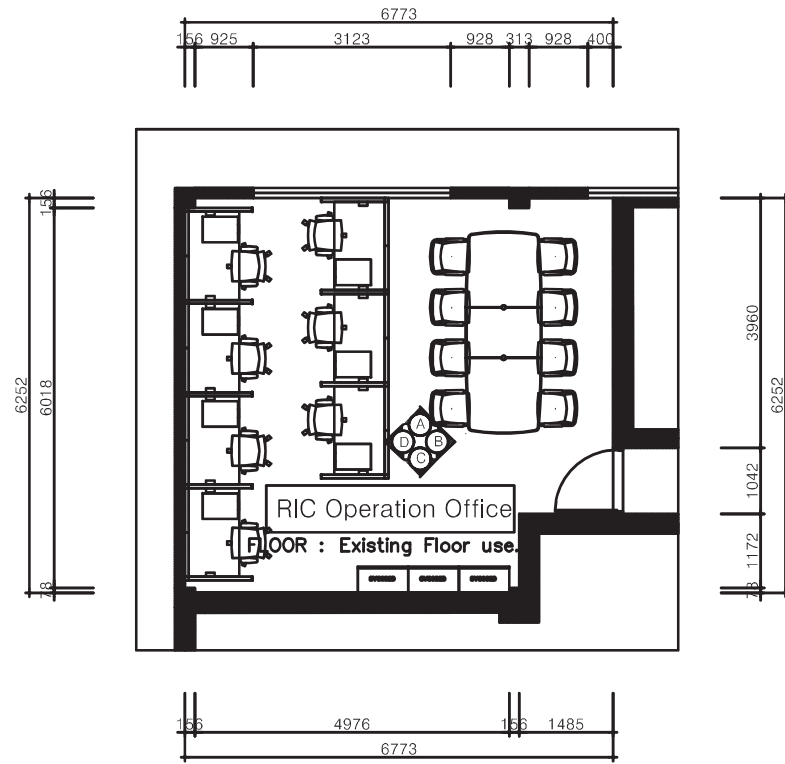

FLOOR PLAN

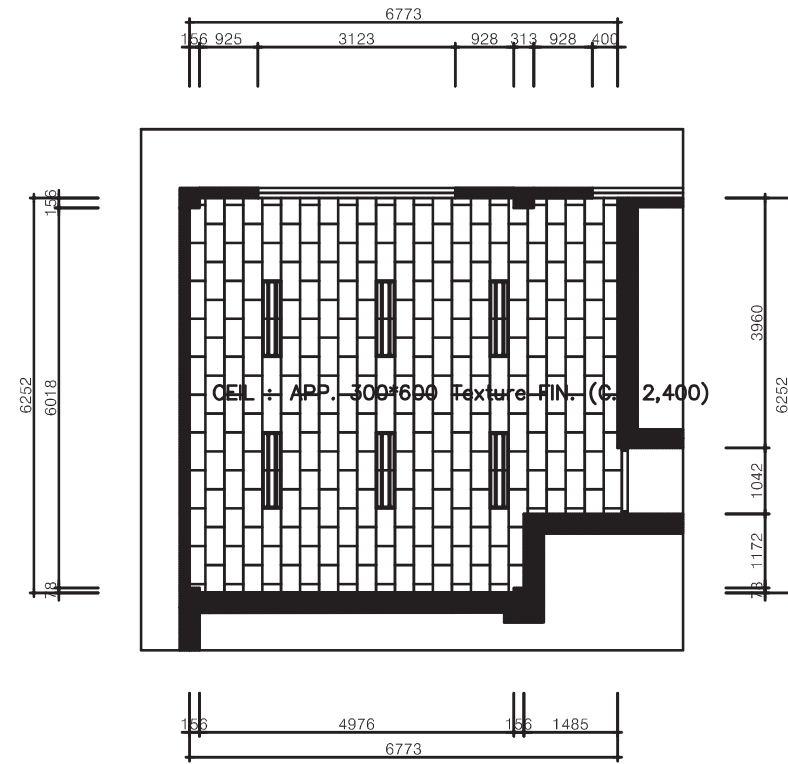

CEILING PLAN

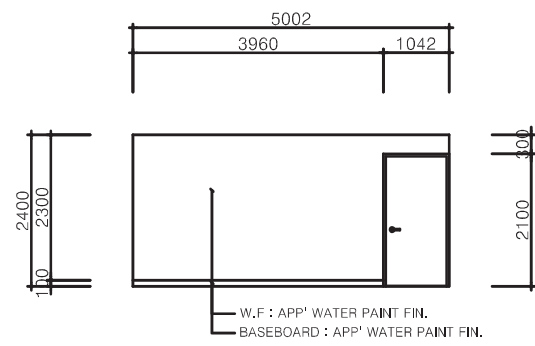
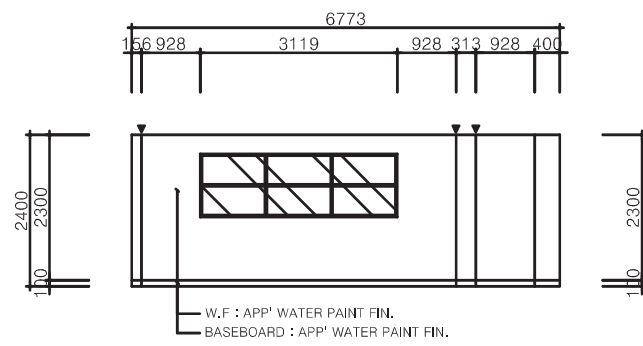

ELEVATION_A/B

ELEVATION_C/D

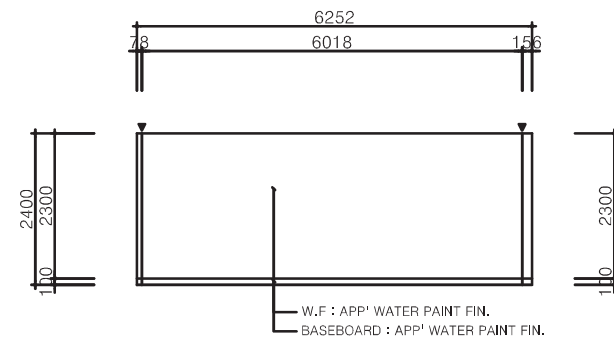
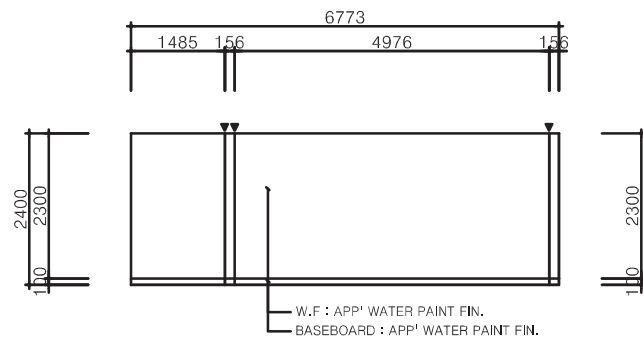

NOTE

DATE

DRAWN BY

DESIGNED BY

CHECKED BY

APPROVED BY

PROJECT TITLE

DRAWN TITLE

SCALE

SHEET NO.
DRAWN NO.

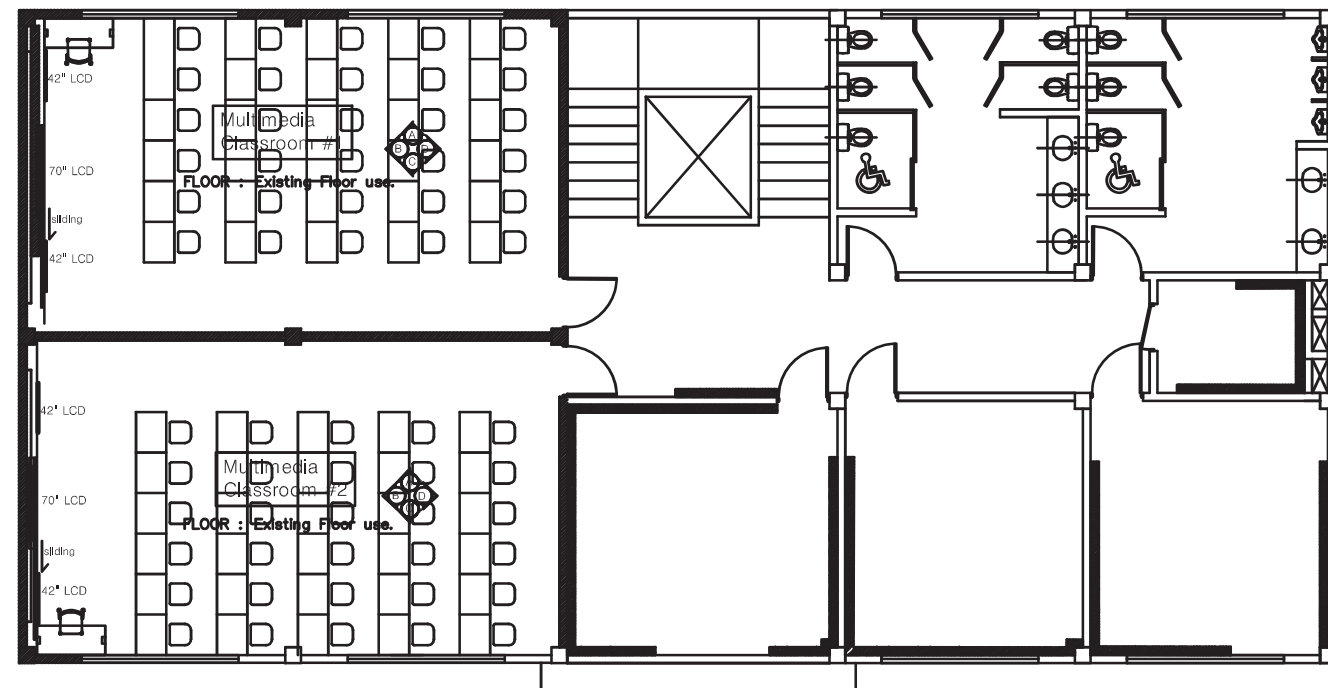

NOTE

DATE

DRAWN BY

DESIGNED BY

CHECKED BY

APPROVED BY

PROJECT TITLE

DRAWN TITLE

SCALE

SHEET NO.
DRAWN NO.

Universidad de Cartagena_3rd Floor Plan for Construction

SCALE
1/150

1

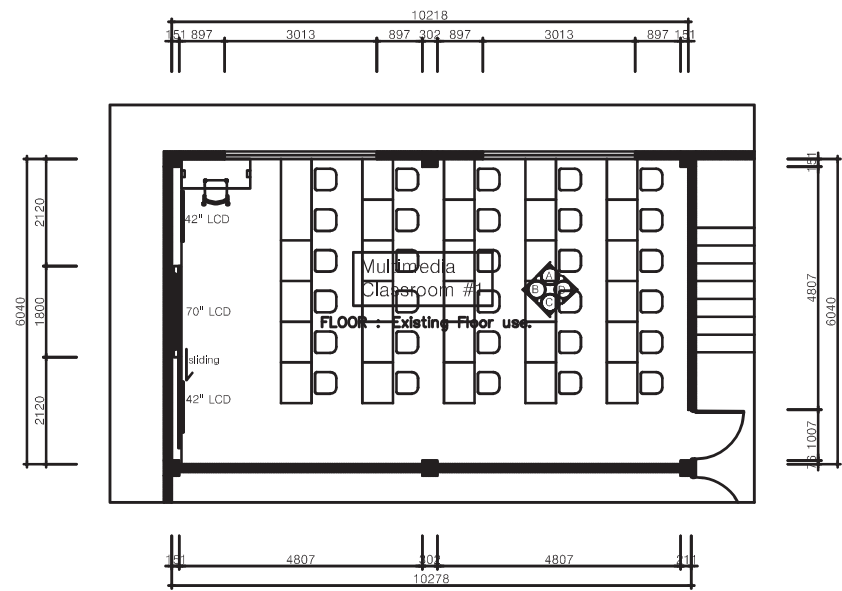

FLOOR PLAN

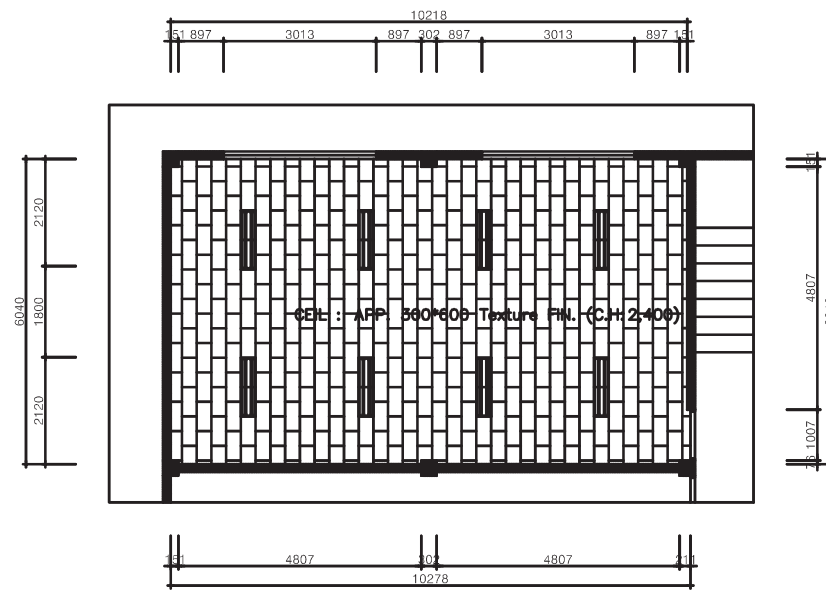

CEILING PLAN

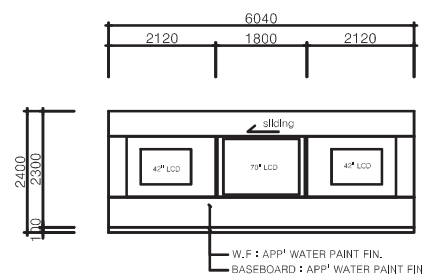
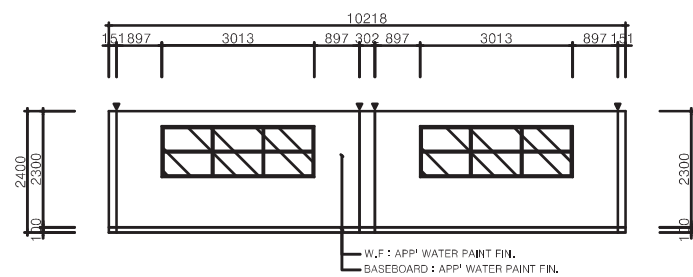

ELEVATION_A/B

ELEVATION_C/D

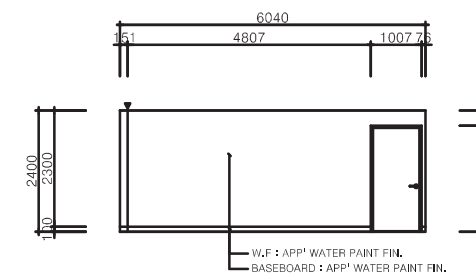
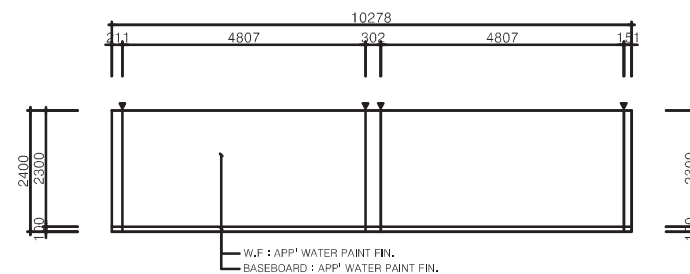

NOTE

DATE

DRAWN BY

DESIGNED BY

CHECKED BY

APPROVED BY

PROJECT TITLE

DRAWN TITLE

SCALE

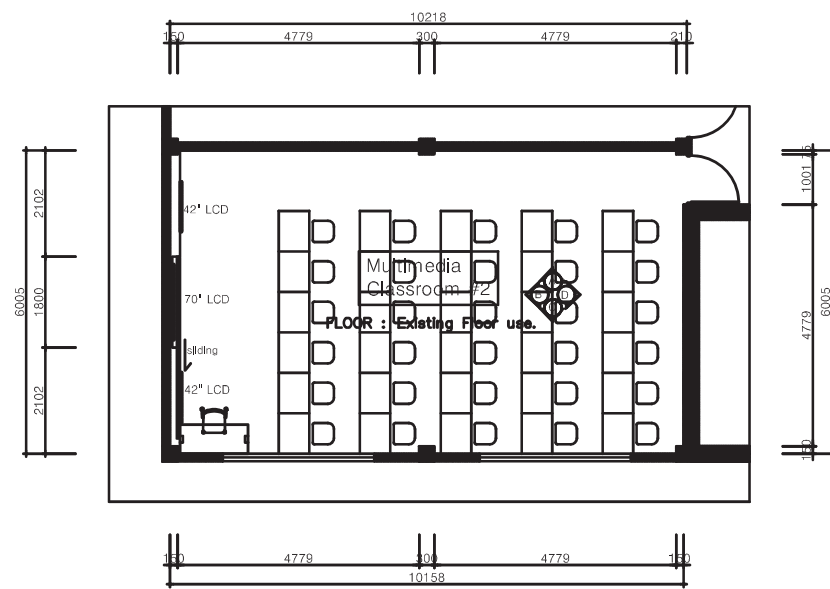

FLOOR PLAN

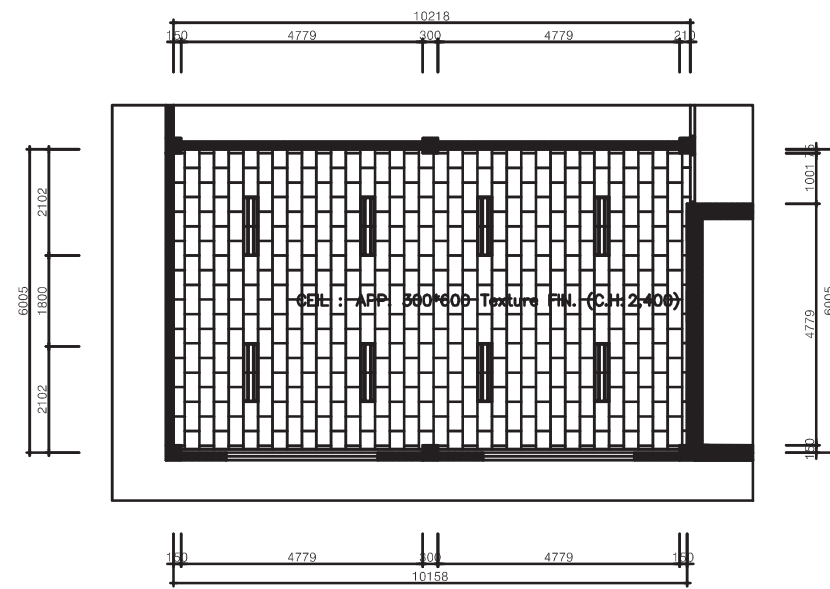

CEILING PLAN

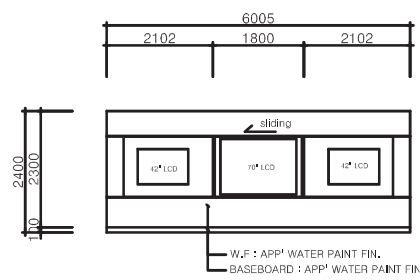
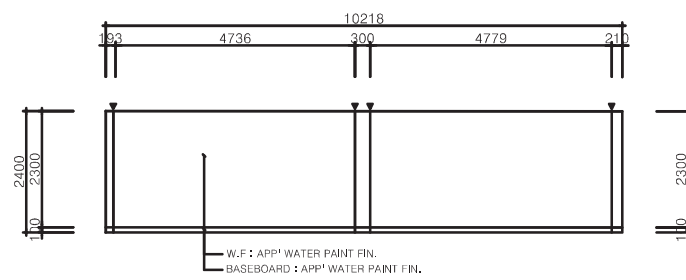

ELEVATION_A/B

ELEVATION_C/D

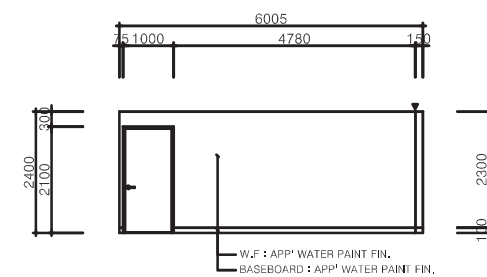
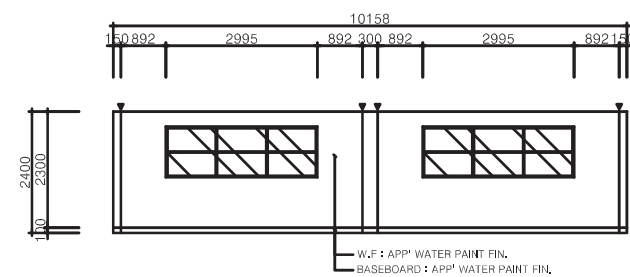

NOTE

DATE

DRAWN BY

DESIGNED BY

CHECKED BY

APPROVED BY

PROJECT TITLE

DRAWN TITLE

SCALE

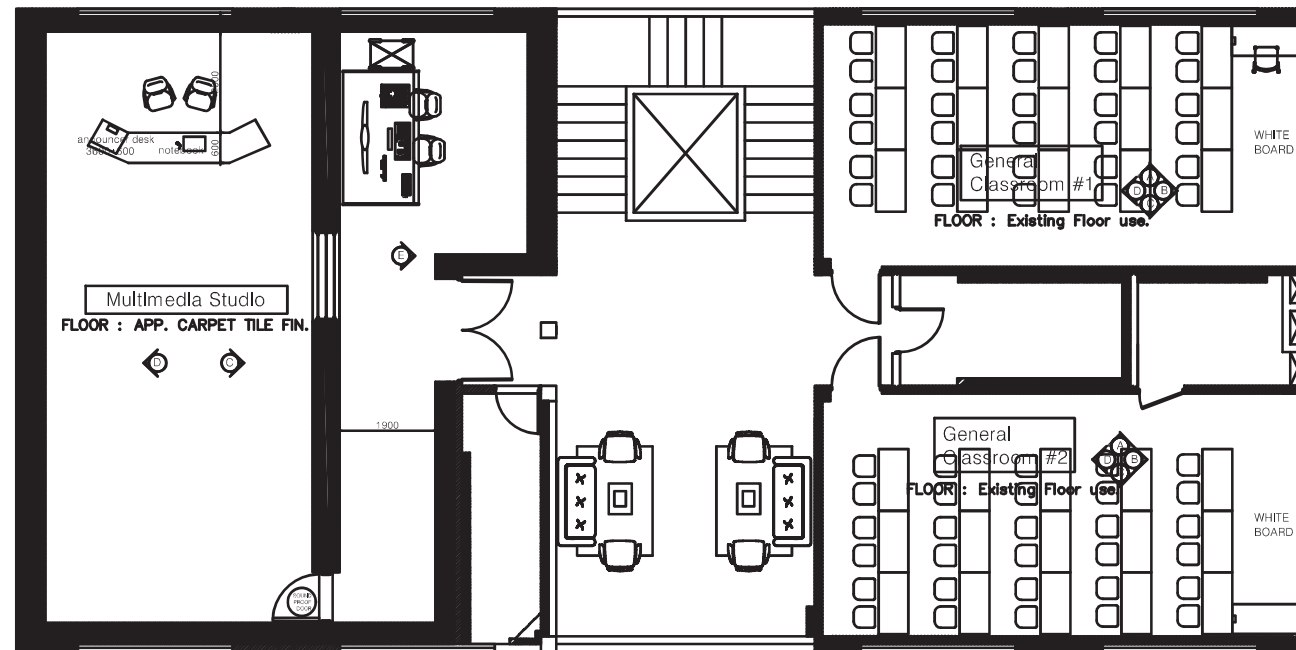

NOTE

DATE

DRAWN BY

DESIGNED BY

CHECKED BY

APPROVED BY

PROJECT TITLE

DRAWN TITLE

SCALE

SHEET NO.
DRAWN NO.

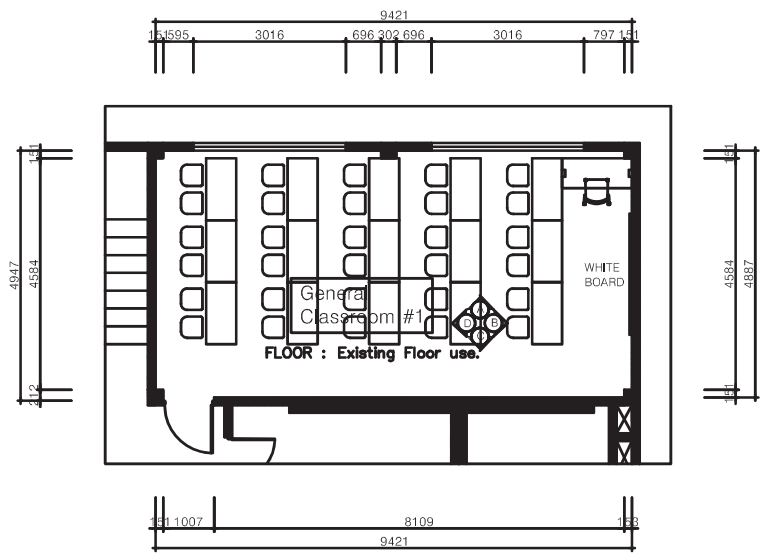

FLOOR PLAN

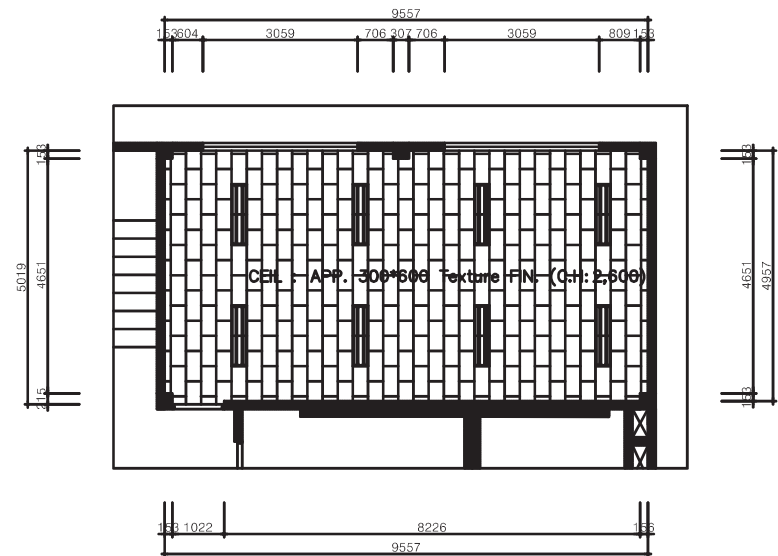

CEILING PLAN

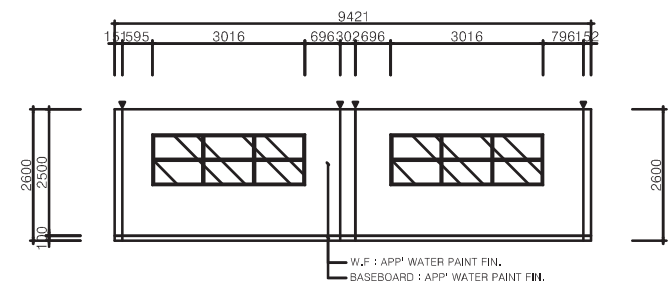

ELEVATION_C/D

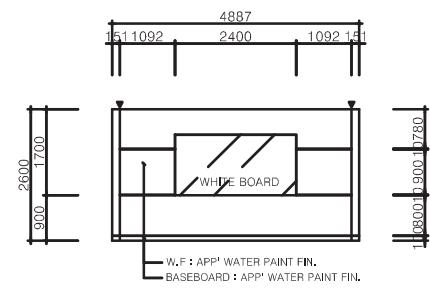

ELEVATION_A/B

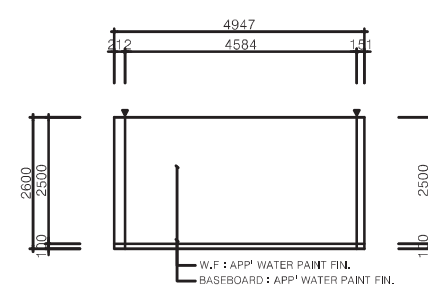
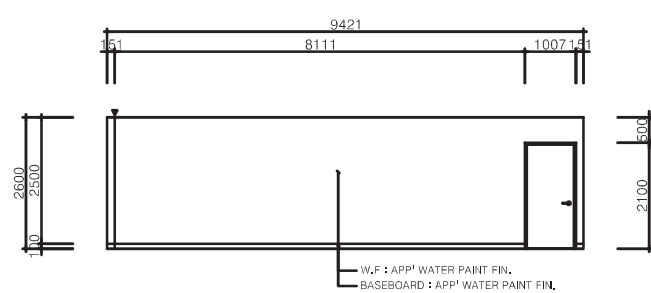

NOTE

DATE

DRAWN BY

DESIGNED BY

CHECKED BY

APPROVED BY

PROJECT TITLE

DRAWN TITLE

SCALE

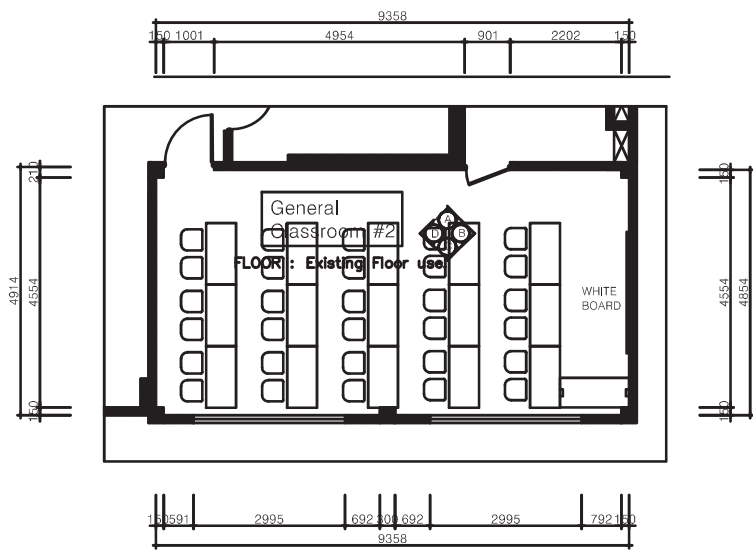

FLOOR PLAN

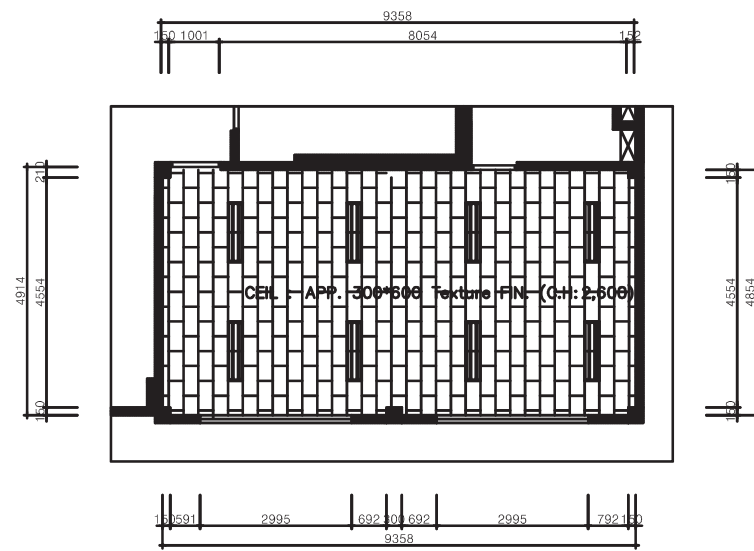

CEILING PLAN

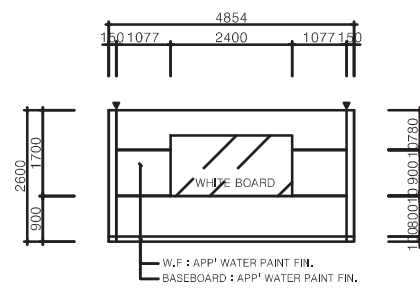
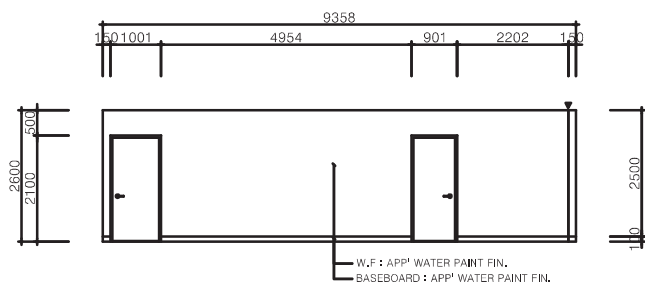

ELEVATION_A/B

ELEVATION_C/D

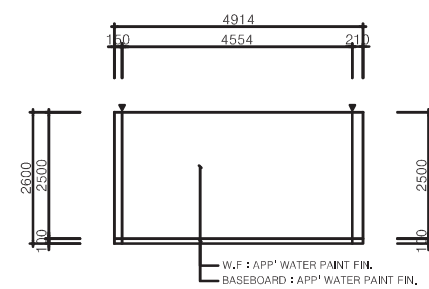
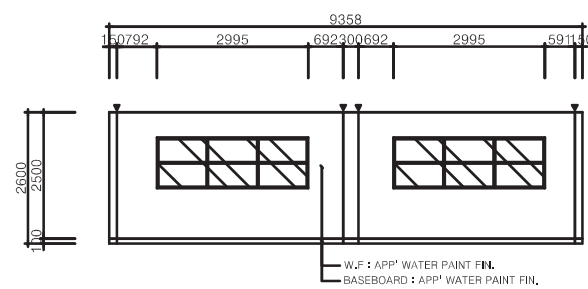

NOTE

DATE

DRAWN BY

DESIGNED BY

CHECKED BY

APPROVED BY

PROJECT TITLE

DRAWN TITLE

SCALE

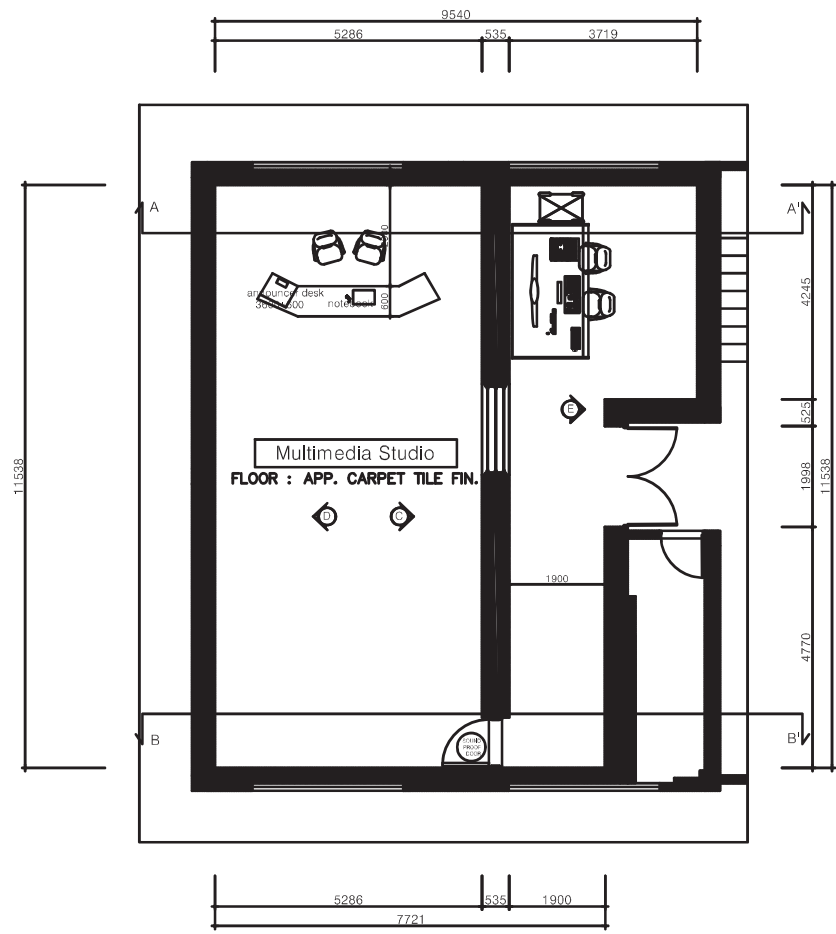

FLOOR PLAN

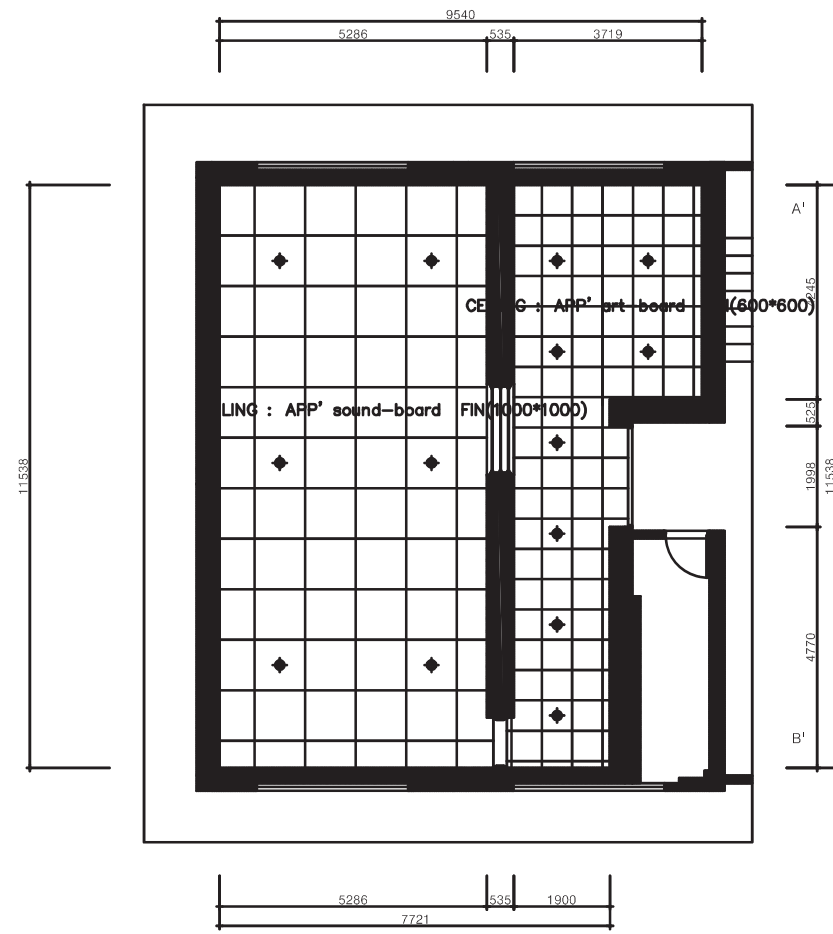

CEILING PLAN

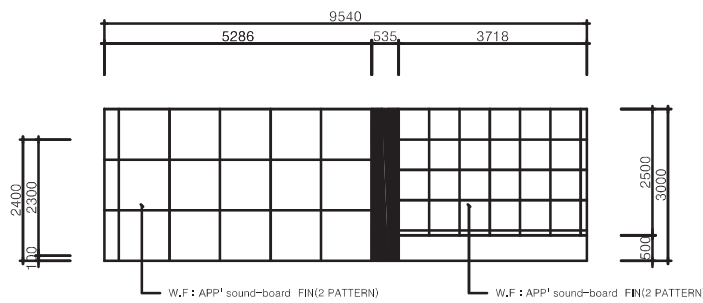

ELEVATION_A-A'

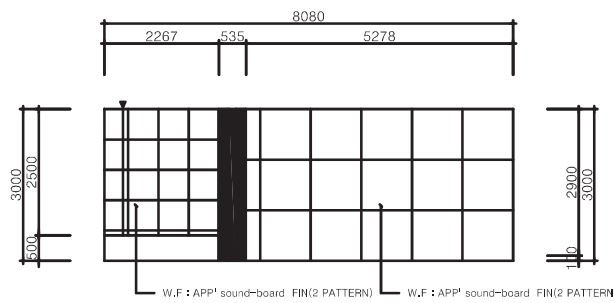

ELEVATION_B-B'

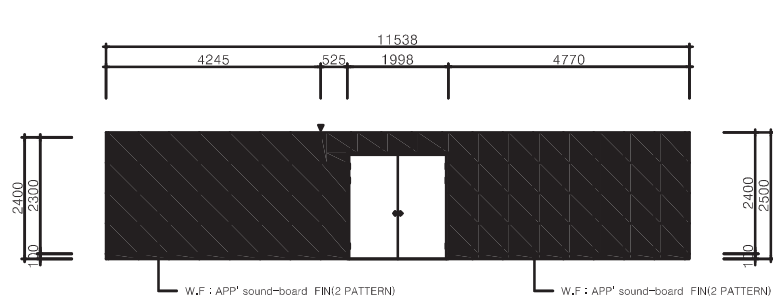

ELEVATION_C

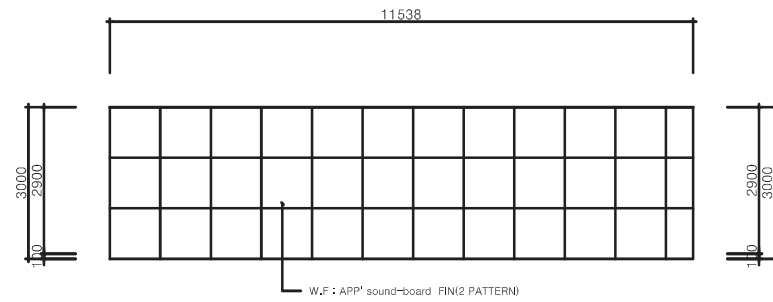

ELEVATION_D

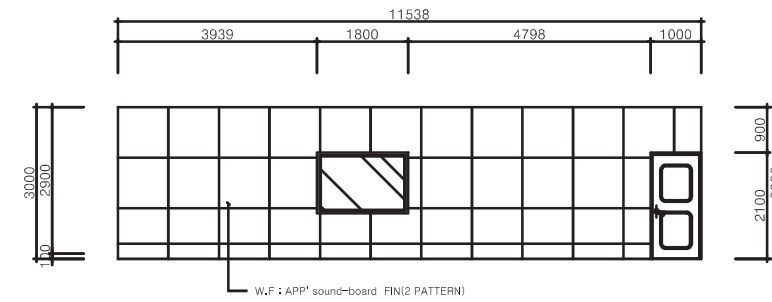

ELEVATION_E

NOTE

DATE

DRAWN BY

DESIGNED BY

CHECKED BY

APPROVED BY

PROJECT TITLE

DRAWN TITLE

SCALE

SHEET NO.

DRAWN NO.