

Attachment 5. Floor plans of RIC

1. Alianza CIER Centro (Central RIC) – Bogota
2. Alianza Oriente – Villavicencio
3. Alianza Innovatic – Medellin
4. Alianza Sur Occidente – Cali
5. Alianza CIER Norte - Cartagena

1. Alianza CIER Centro (Central RIC) – Bogota

* Space information of the Palace of San Francisco

RIC	Office	Building Name	Floor	Size(W X D X H)	Remark
Alianza CIER Centro (Bogota)	RIC Operation Office	Palace of San Francisco	3 rd Floor	4.0 X 11.5 X 4.2	
	Multimedia Studio	Palace of San Francisco	3 rd Floor	12.2 X 7.7 X 4.2 5.1 X 4.1 X 4.2	
	Content Development and Research Office	Palace of San Francisco	3 rd Floor	3.3 X 8.2 X 4.2 8.6 X 5.8 X 4.2	
	Multimedia Classroom #1	Palace of San Francisco	3 rd Floor	10.4 X 6.0 X 4.2	
	Multimedia Classroom #2	Palace of San Francisco	3 rd Floor	10.4 X 6.0 X 4.2	
	General Classroom #1	Palace of San Francisco	2 nd Floor	6.3 X 10.7 X 4.2	
	General Classroom #2	Palace of San Francisco	2 nd Floor	14 X 5.9 X 4.2	
	Server Room	Palace of San Francisco	3 rd Floor	4.0 X 5.1 X 4.2	

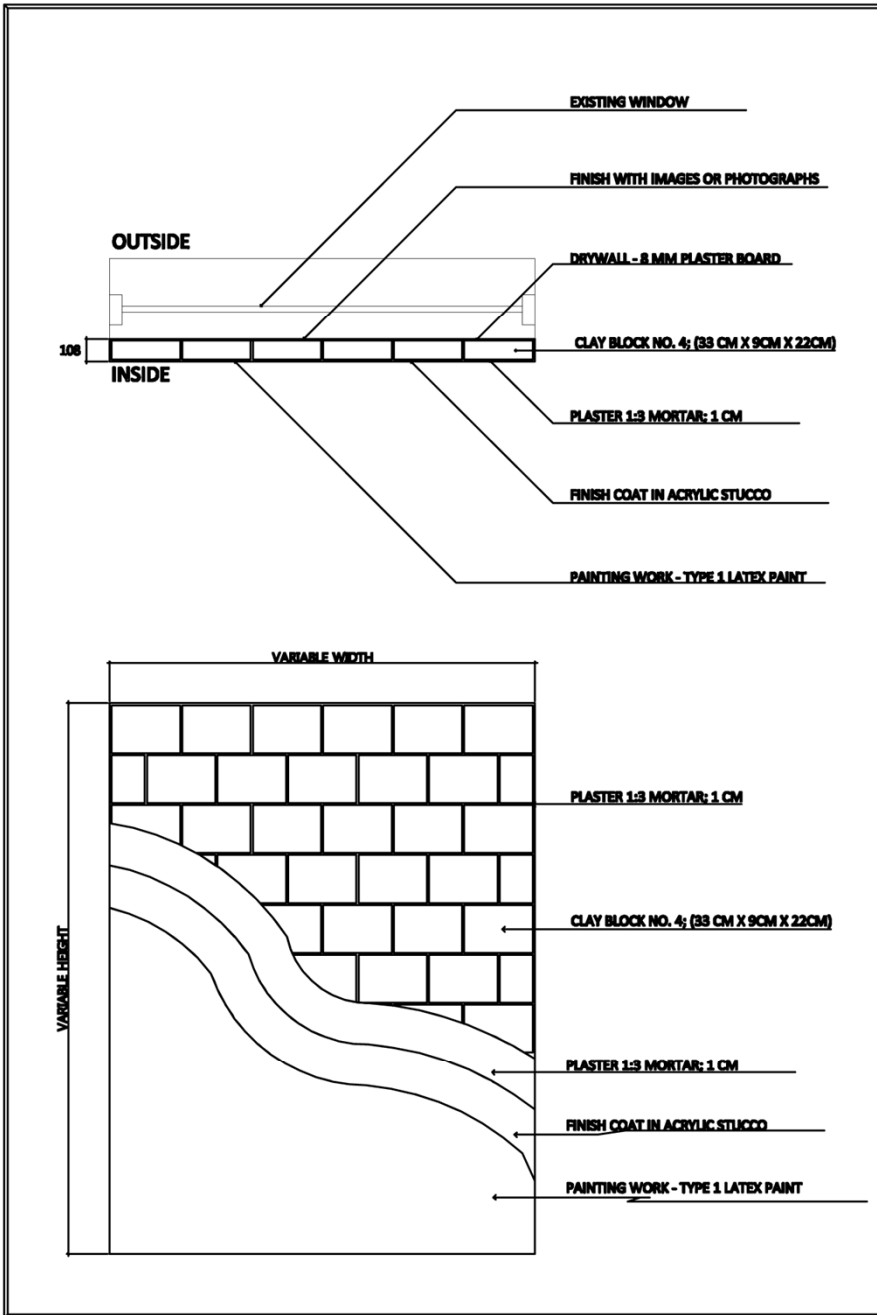

DET. 1

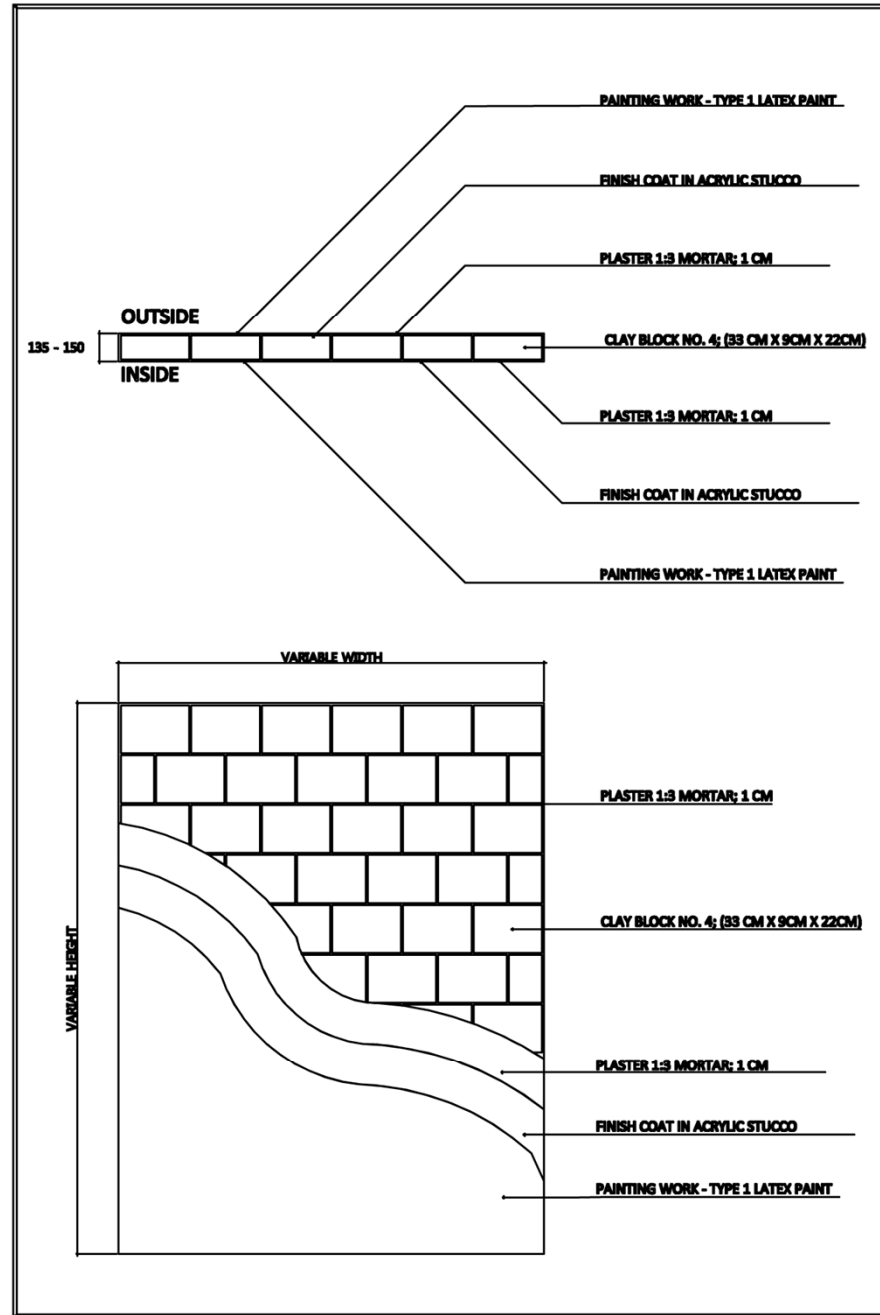

DET. 2

NOTE

DATE

DRAWN BY

DESIGNED BY

CHECKED BY

APPROVED BY

PROJECT TITLE

DRAWN TITLE

SCALE

SHEET NO.
DRAWING NO.

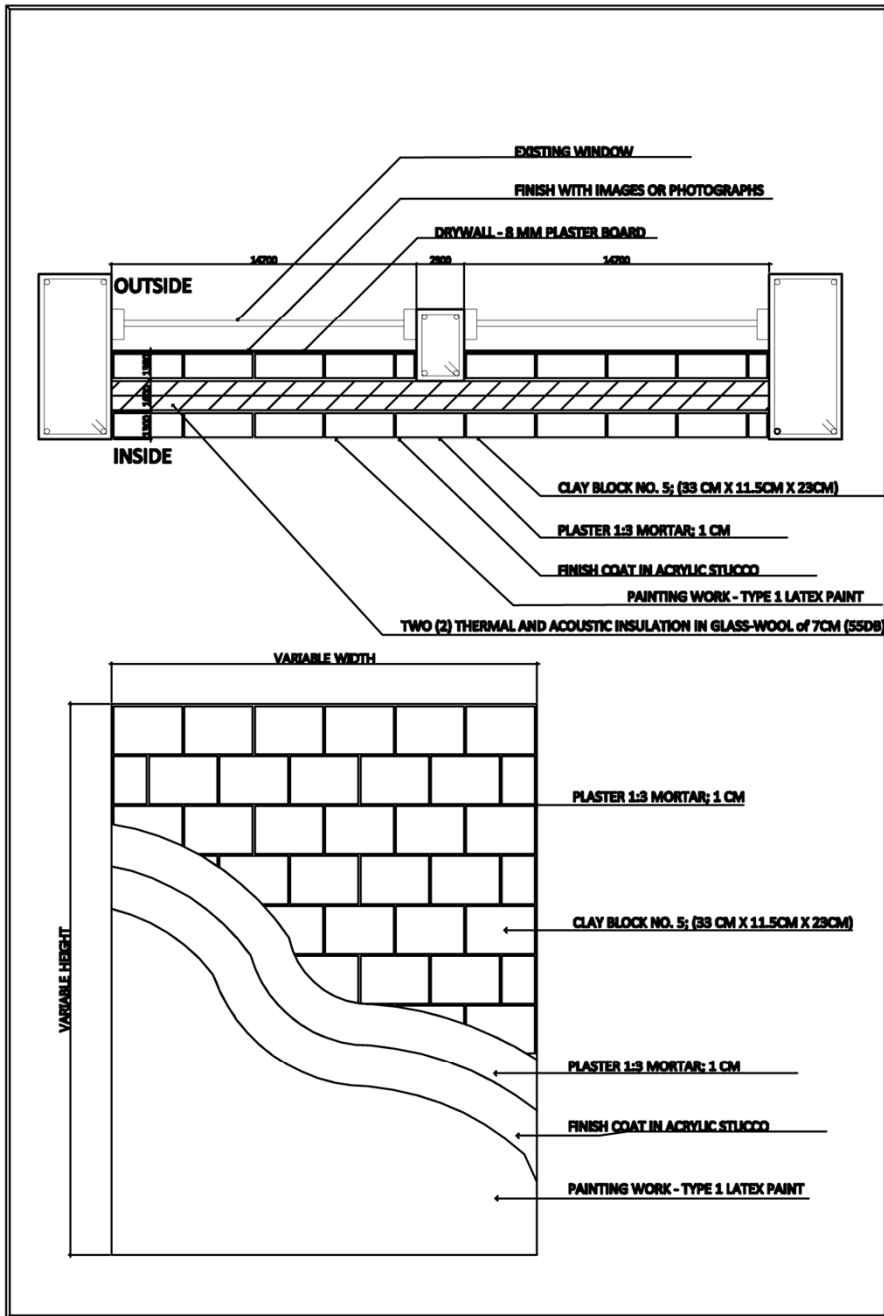

DET. 3

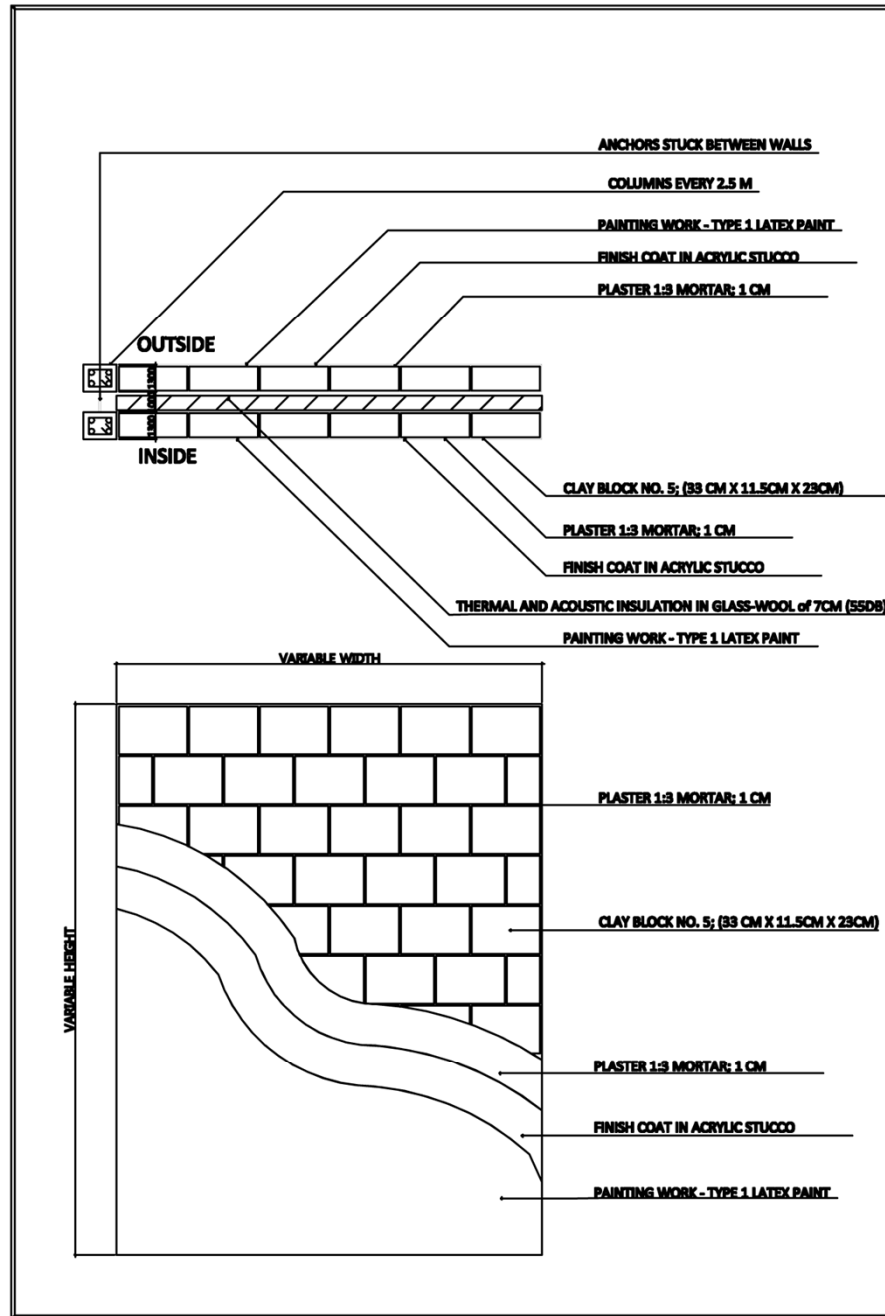

DET. 4

NOTE

DATE

DRAWN BY

DESIGNED BY

CHECKED BY

APPROVED BY

PROJECT TITLE

DRAWN TITLE

SCALE

SHEET NO.

DRAWN NO.

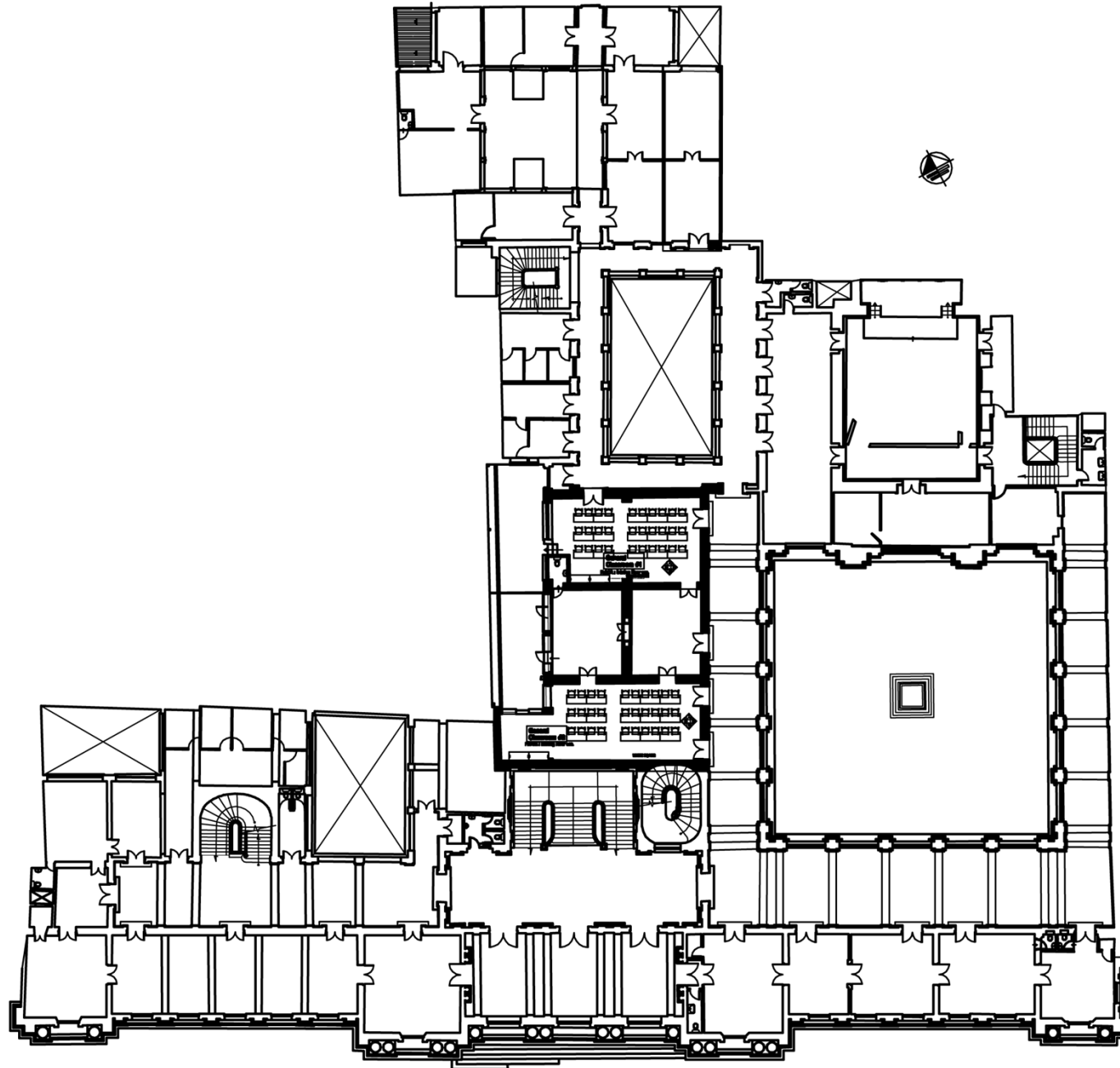

NOTE

DATE

DRAWN BY

DESIGNED BY

CHECKED BY

APPROVED BY

PROJECT TITLE

DRAWN TITLE

SCALE

SHEET NO.

DRAWING NO.

Palace of San Francisco_2nd Floor Plan

SCALE
1/300

1

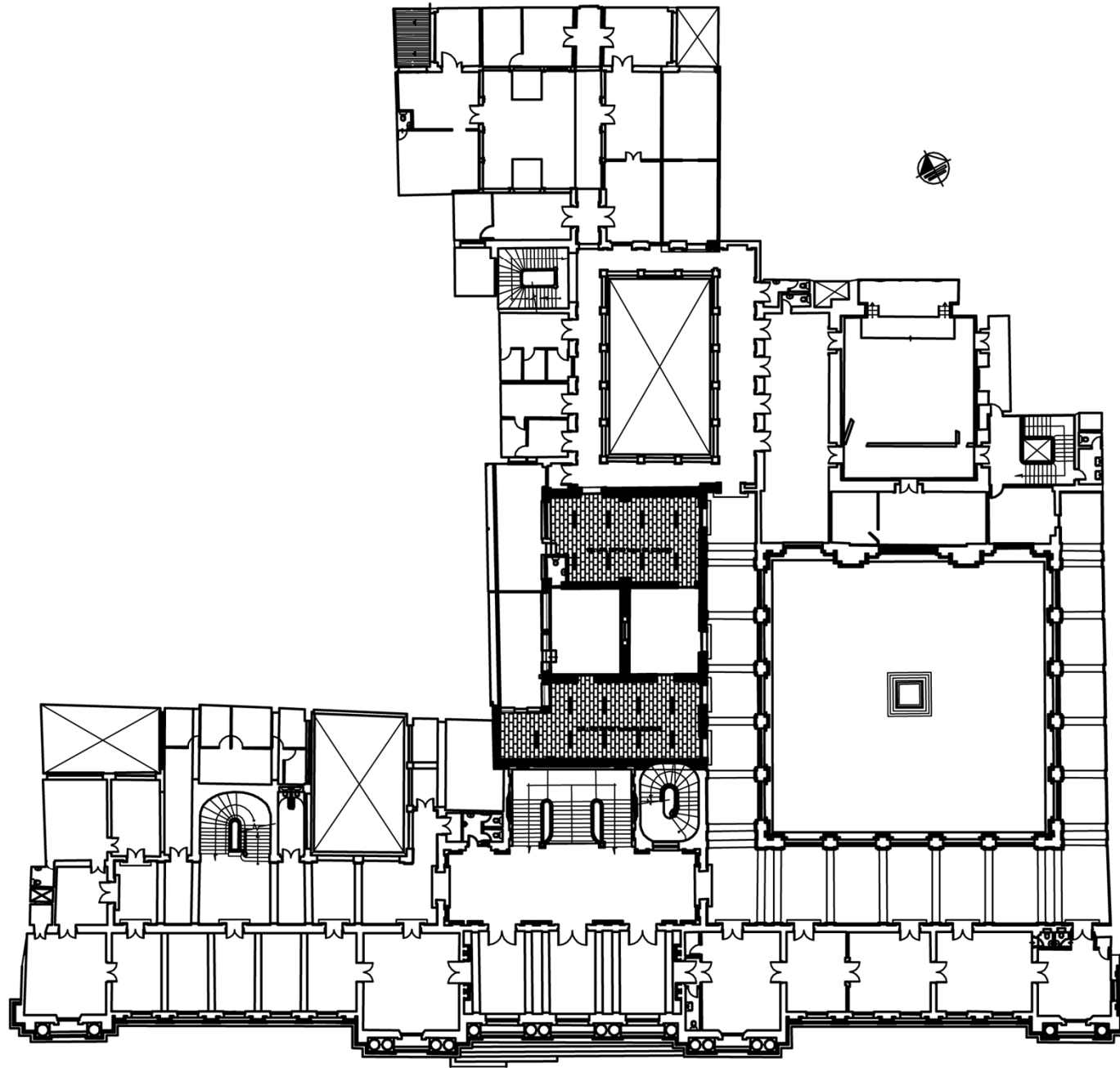

NOTE

DATE

DRAWN BY

DESIGNED BY

ORDERED BY

APPROVED BY

PROJECT TITLE

DRAWN TITLE

SCALE

SHEET NO.

DRAWING NO.

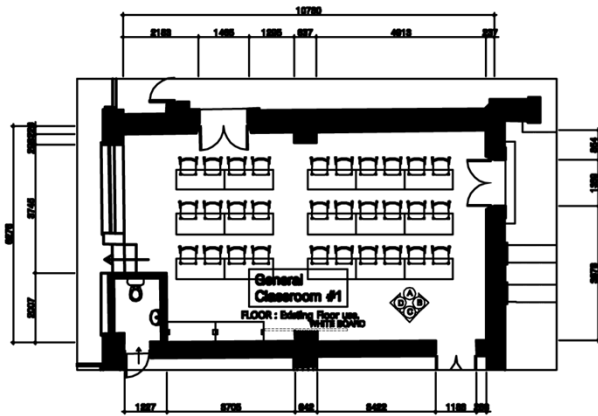

FLOOR PLAN

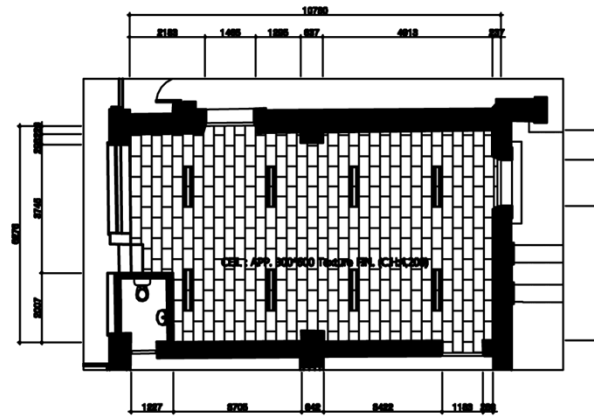

CEILING PLAN

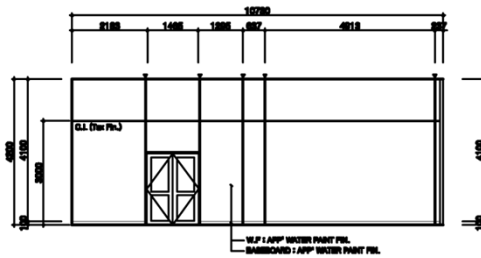

ELEVATION_A/B

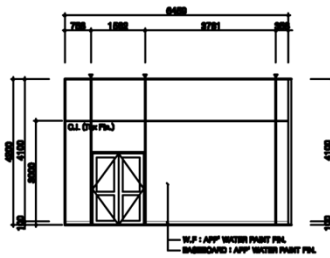

ELEVATION_C/D

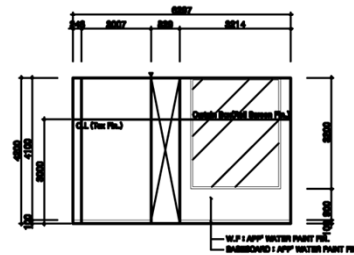
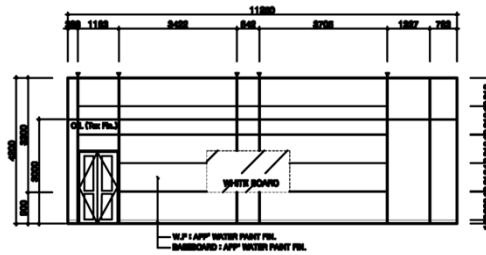

NOTE

DATE

DRAWN BY

DESIGNED BY

CHECKED BY

APPROVED BY

PROJECT TITLE

DRAWN TITLE

SCALE

SCALE
1/150

1

SHEET NO.
DRAWN NO.

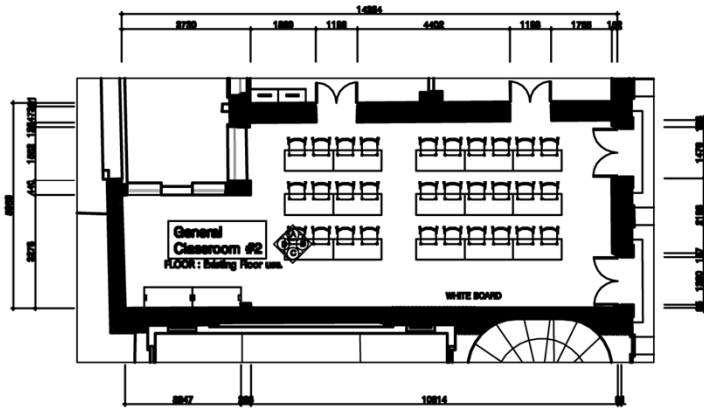

FLOOR PLAN

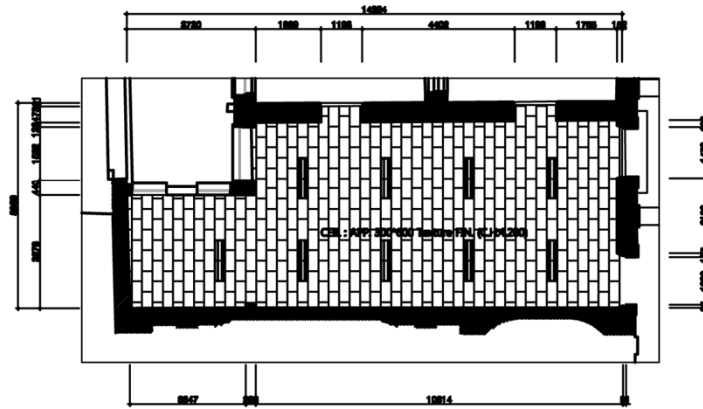

CEILING PLAN

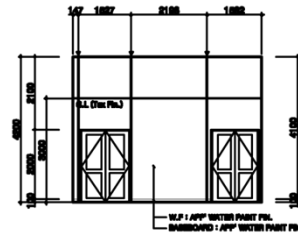
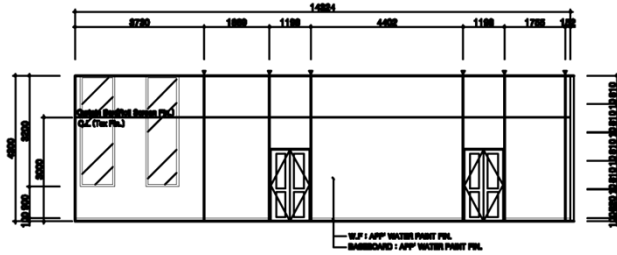

ELEVATION_A/B

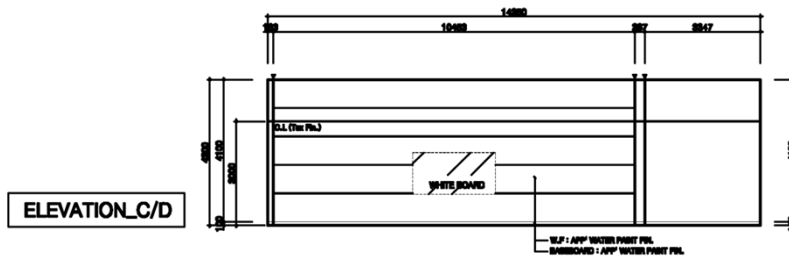

ELEVATION_C/D

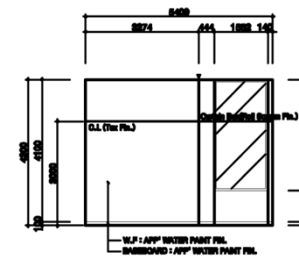

NOTE

DATE

DRAWN BY

DESIGNED BY

CHECKED BY

APPROVED BY

PROJECT TITLE

DRAWN TITLE

SCALE

SCALE
1/150

1

SHEET NO.
DRAWN NO.

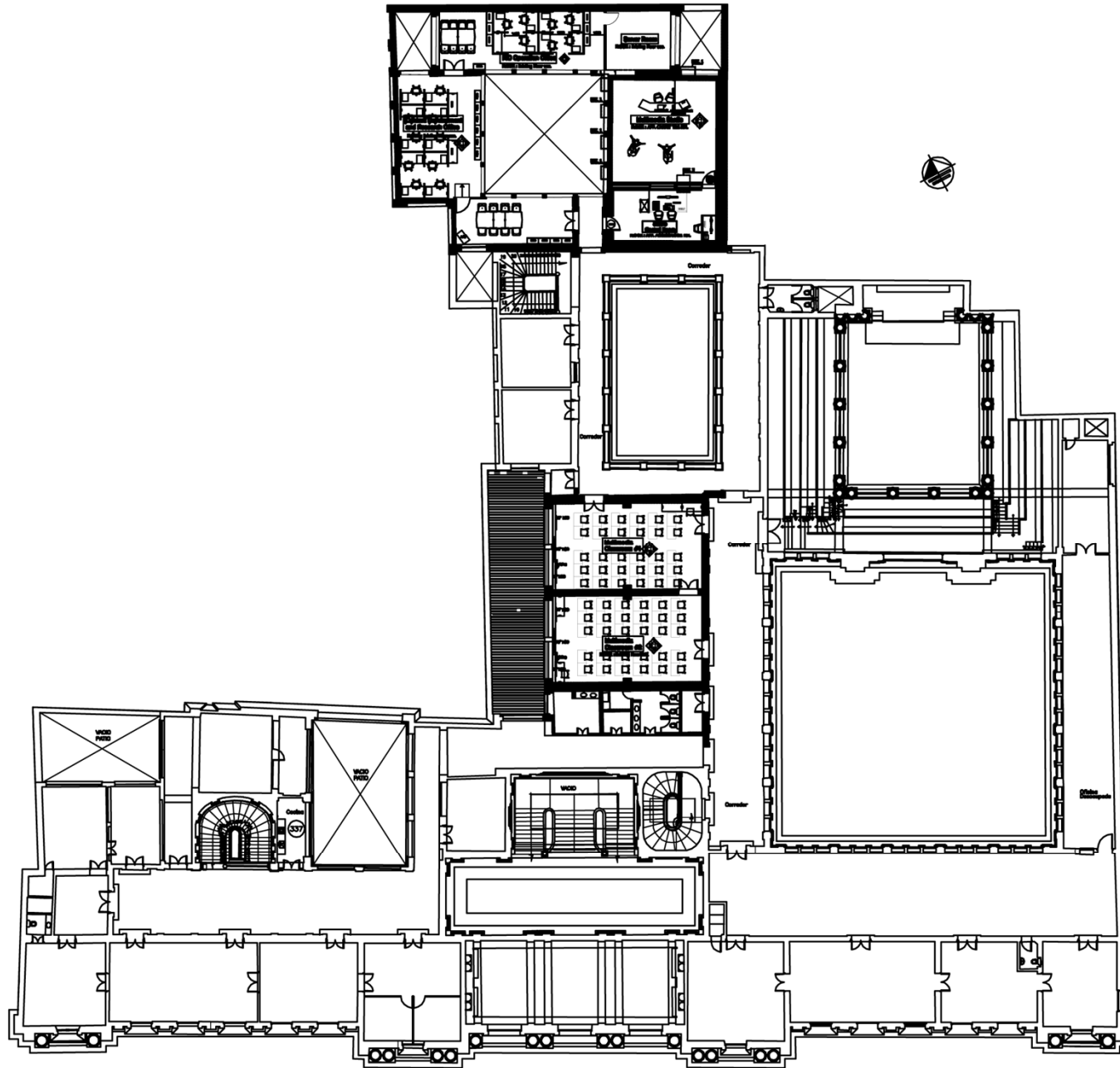

NOTE

DATE

DRAWN BY

DESIGNED BY

CHECKED BY

APPROVED BY

PROJECT TITLE

DRAWN TITLE

SCALE

SHEET NO.
DRAWING NO.

Palace of San Francisco_3rd Floor Plan

SCALE
1/300

1

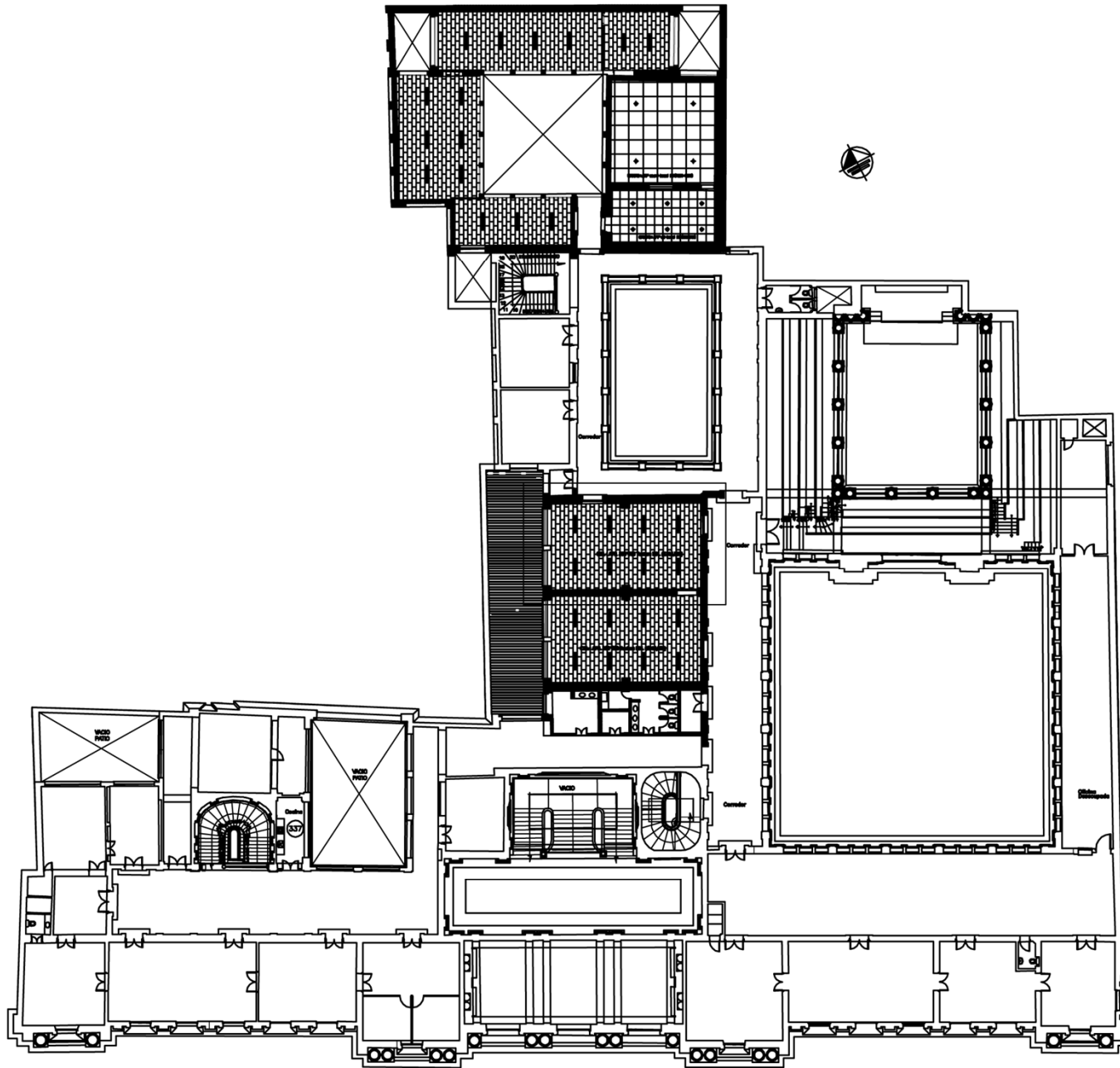

NOTE

DATE

DRAWN BY

DESIGNED BY

CHECKED BY

APPROVED BY

PROJECT TITLE

DRAWN TITLE

SCALE

SHEET NO.

DRAWN NO.

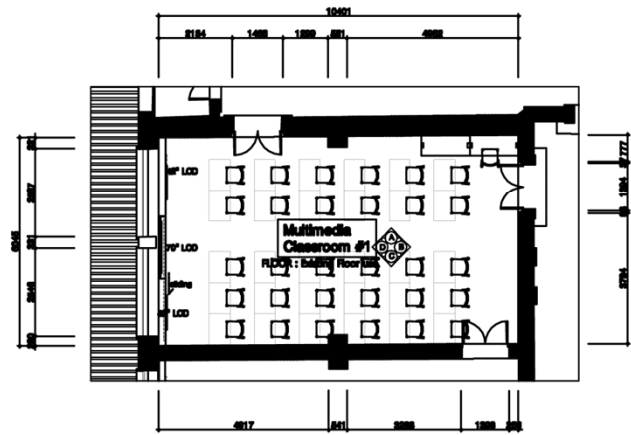

FLOOR PLAN

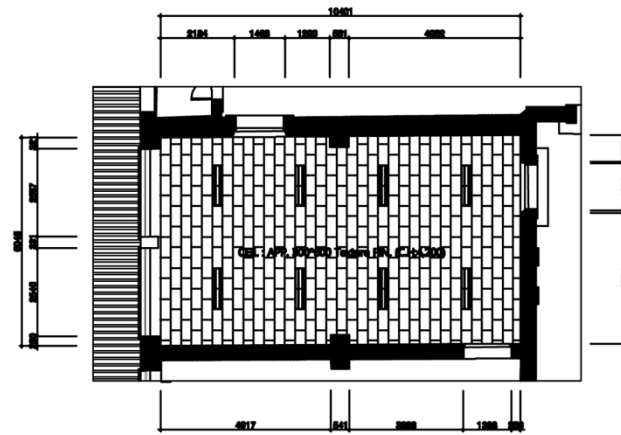

CEILING PLAN

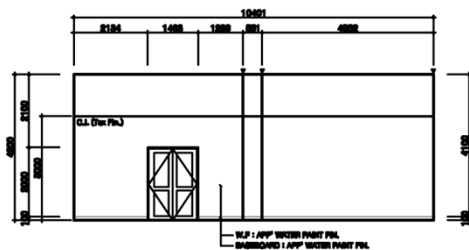

ELEVATION_A/B

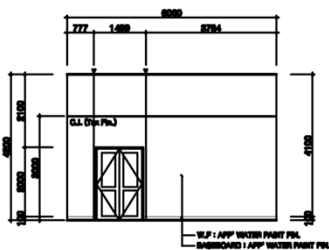

ELEVATION_C/D

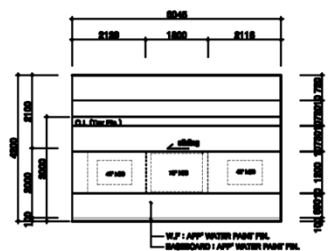
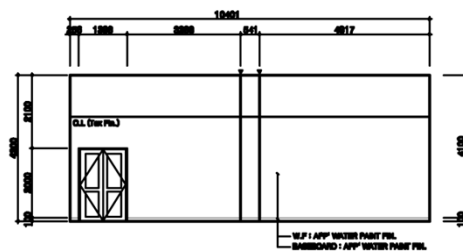

NOTE

DATE

DRAWN BY

DESIGNED BY

CHECKED BY

APPROVED BY

PROJECT TITLE

DRAWN TITLE

SCALE

SHEET NO.

DRAWN NO.

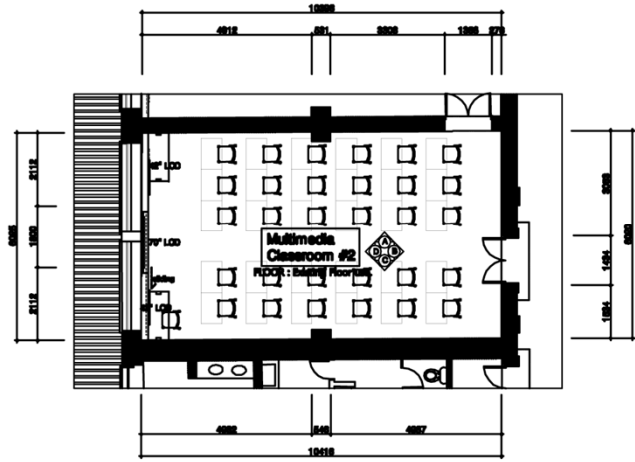

FLOOR PLAN

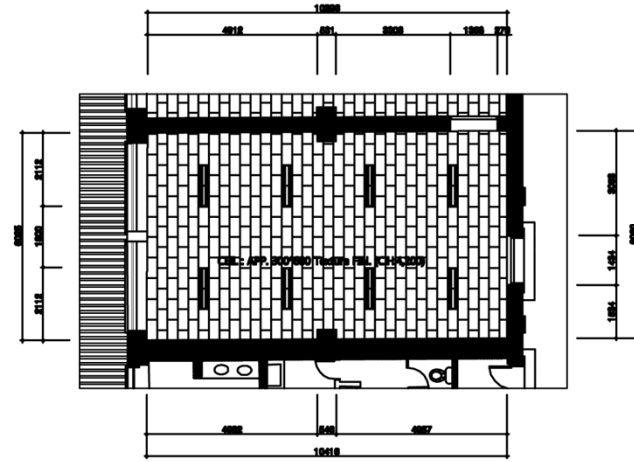

CEILING PLAN

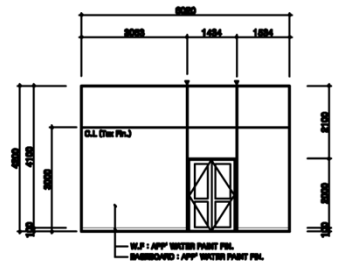
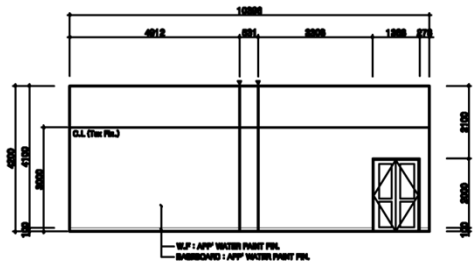

ELEVATION_A/B

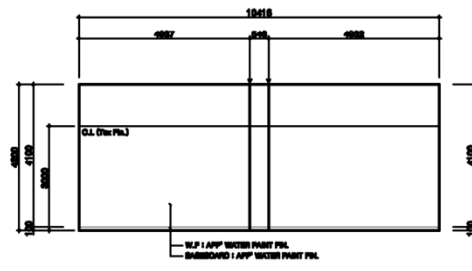

ELEVATION_C/D

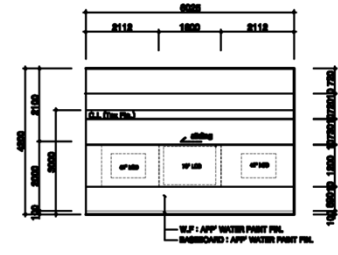

NOTE

DATE

DRAWN BY

DESIGNED BY

CHECKED BY

APPROVED BY

PROJECT TITLE

DRAWN TITLE

SCALE

SHEET NO.
DRAWN NO.

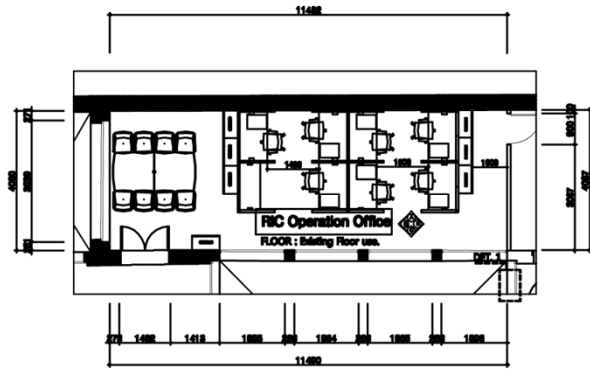

FLOOR PLAN

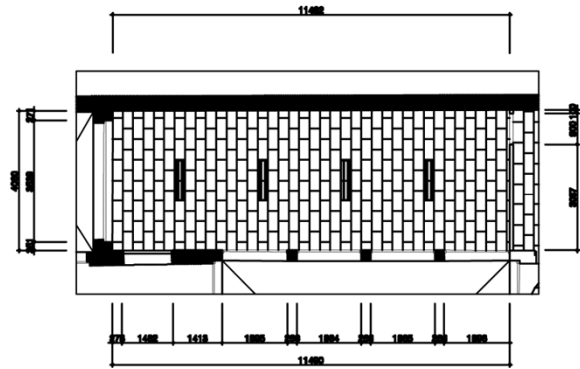

CEILING PLAN

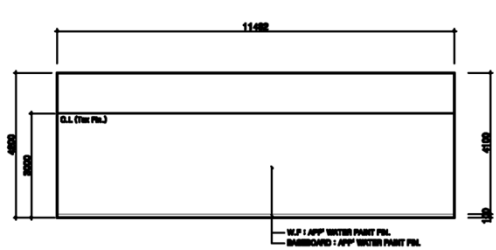

ELEVATION_A/B

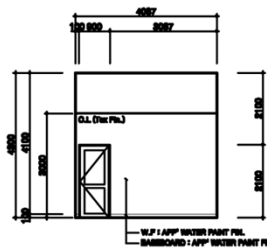

ELEVATION_C/D

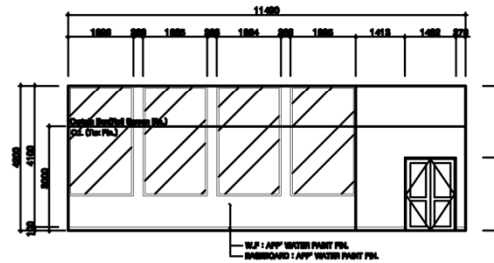
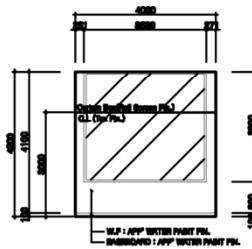

NOTE

DATE

DRAWN BY

DESIGNED BY

CHECKED BY

APPROVED BY

PROJECT TITLE

DRAWN TITLE

SCALE

SHEET NO.

DRAWN NO.

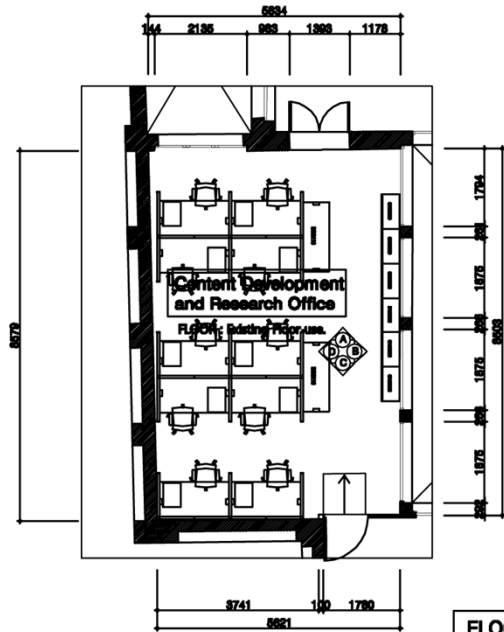

FLOOR PLAN

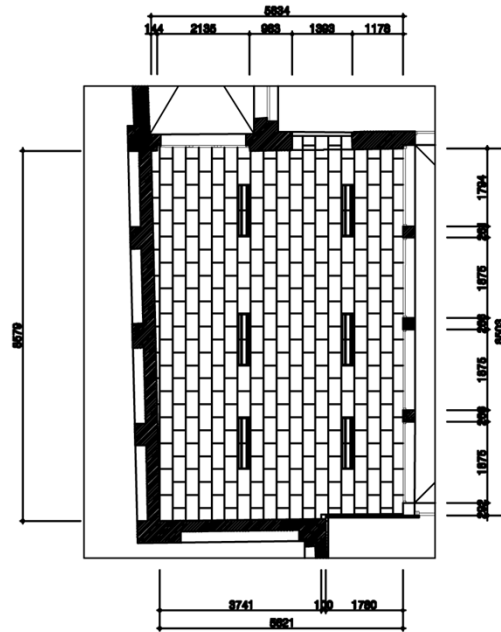

CEILING PLAN

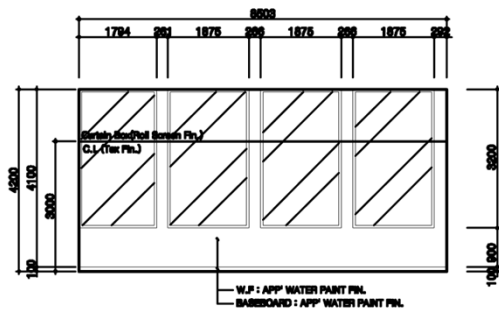
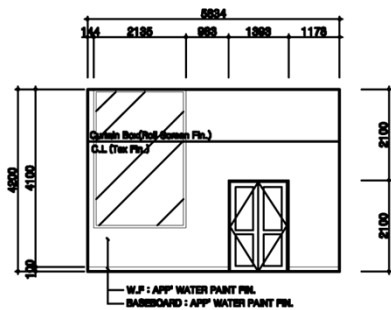

ELEVATION_A/B

ELEVATION_C/D

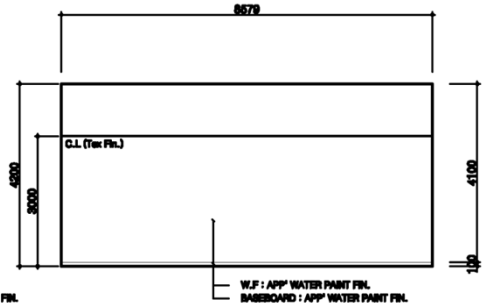
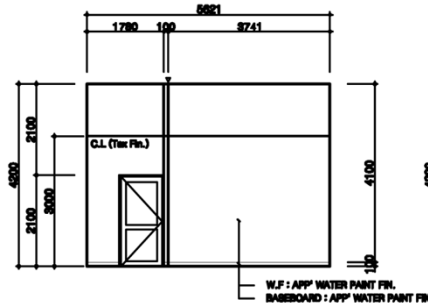

NOTE

DATE

DRAWN BY

DESIGNED BY

ORDERED BY

APPROVED BY

PROJECT TITLE

DRAWN TITLE

SCALE

SHEET NO.

DRAWN NO.

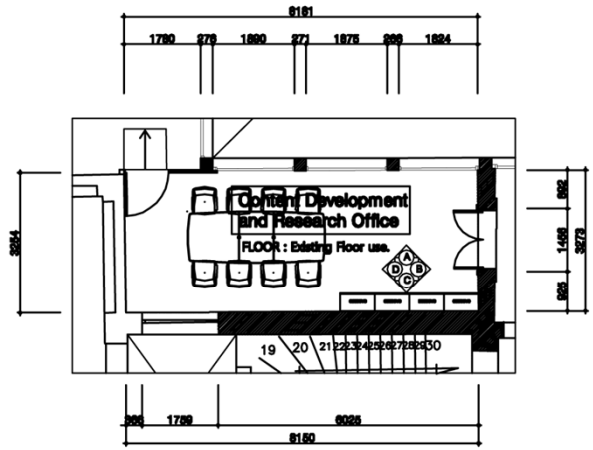

FLOOR PLAN

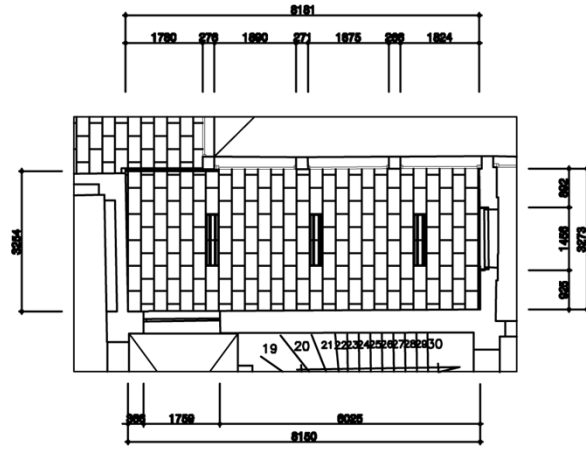

CEILING PLAN

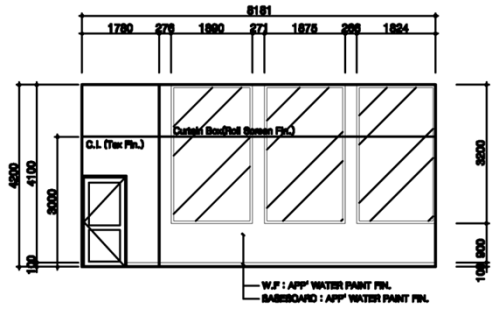

ELEVATION_A/B

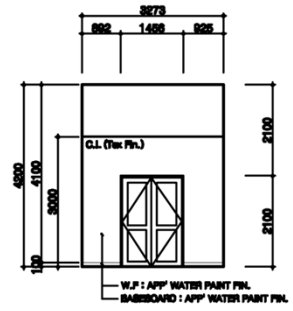

ELEVATION_C/D

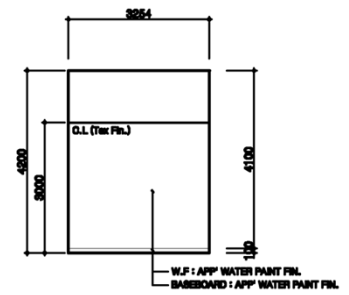
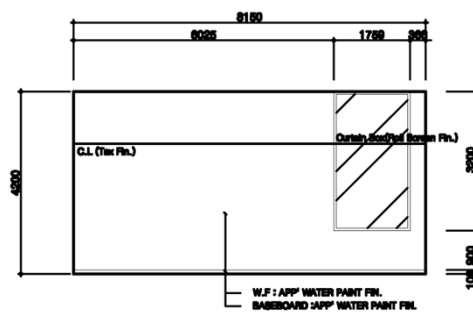

NOTE

DATE

DRAWN BY

DESIGNED BY

CHECKED BY

APPROVED BY

PROJECT TITLE

DRAWN TITLE

SCALE

SCALE
1/120

1

SHEET NO.
DRAWN NO.

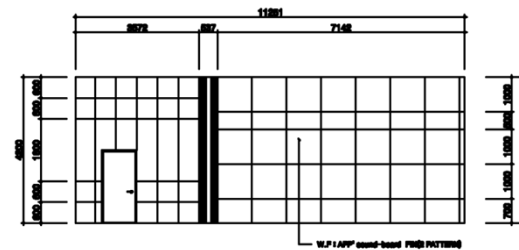
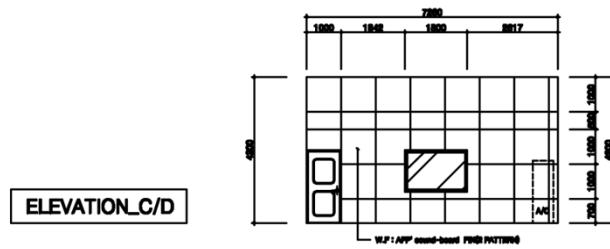
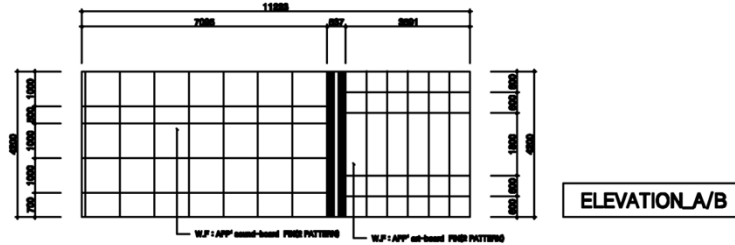
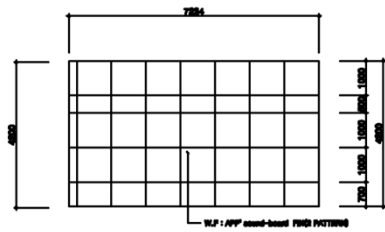
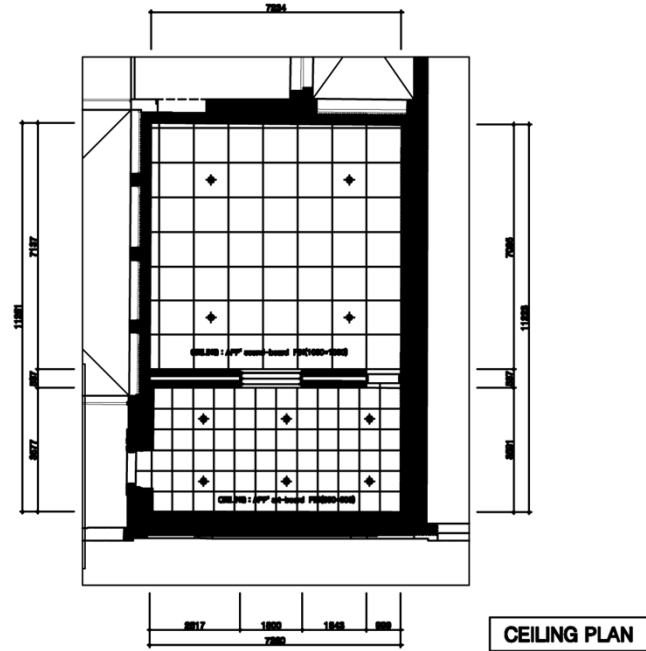
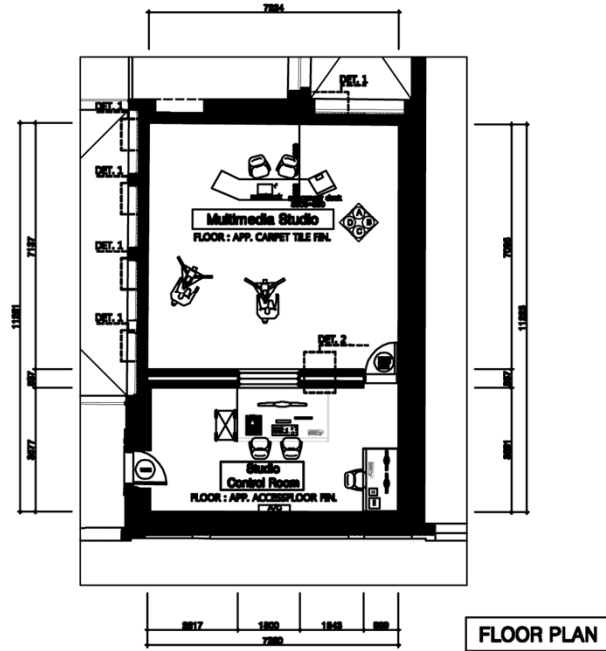

NOTE

DATE

DRAWN BY

DESIGNED BY

CHECKED BY

APPROVED BY

PROJECT TITLE

DRAWN TITLE

SCALE

SHEET NO.
DRAWN NO.

2. Alianza Oriente – Villavicencio

* Space information of the Universidad de Los Llanos

RIC	Office	Building Name	Floor	Size(W X D X H)	Remark
Alianza Oriente (Villavicencio)	RIC Operation Office	Davinci Building	2 nd Floor	7.8 X 5.9 X 2.6	
	Multimedia Studio	New Building	1 st Floor	8.2 X 10.9 X 4(Studio) 8.2 X 4.4 X 4(Control Room)	will be constructed by university
	Content Development and Research Office	Davinci Building	2 nd Floor	7.8 X 7.2 X 2.6	
	Multimedia Classroom #1	Davinci Building	2 nd Floor	11.8 X 9.3 X 2.6	
	Multimedia Classroom #2	Davinci Building	2 nd Floor	11.8 X 9.3 X 2.7	
	General Classroom #1	Davinci Building	1 st Floor	7.4 X 7.6 X 2.3	
	General Classroom #2	Davinci Building	1 st Floor	7.4 X 7.4 X 2.3	
	Server Room	Davinci Building	2 nd Floor	4.4 X 3.9 X 2.7	using the current server room

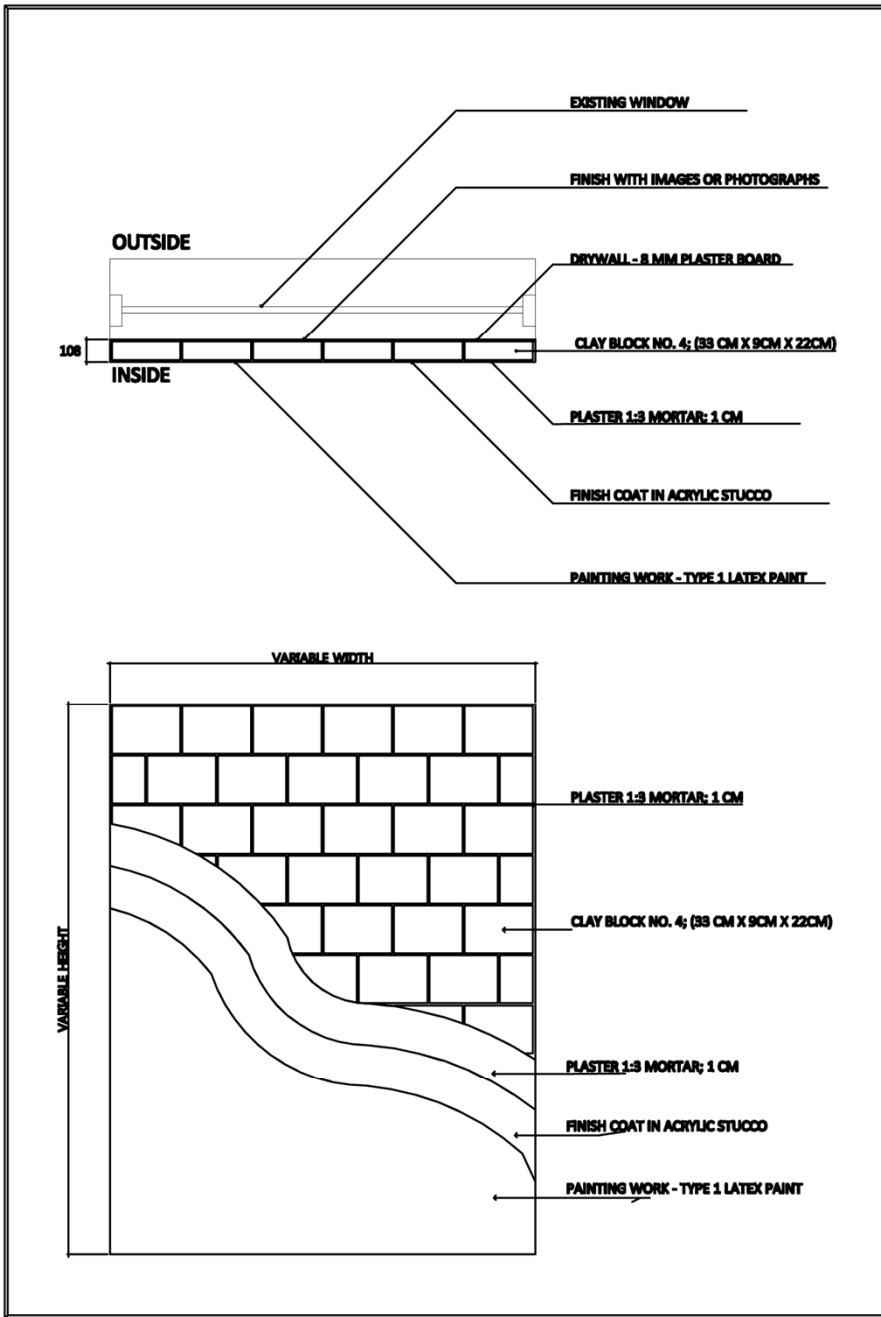

DET. 1

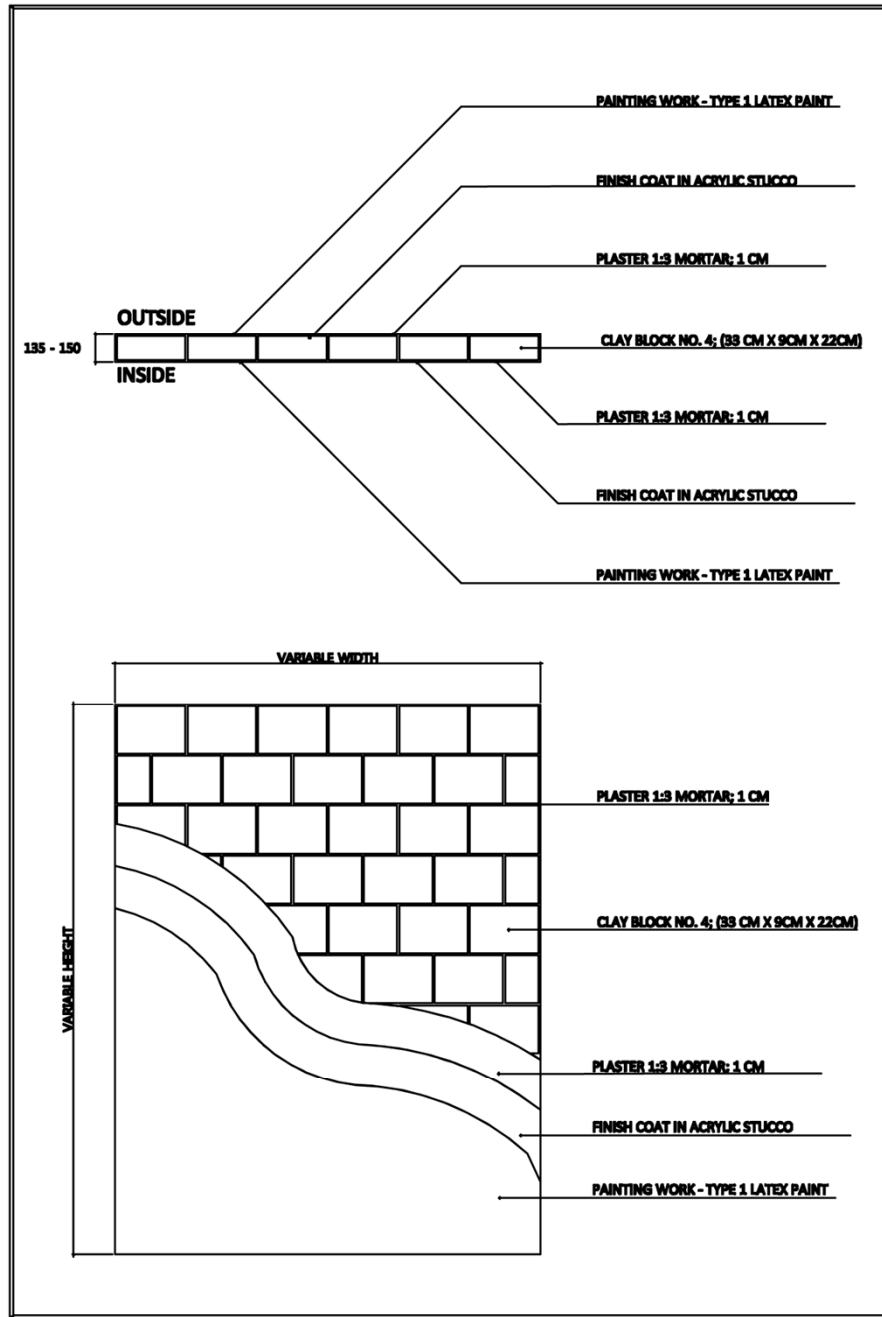

DET. 2

NOTE

DATE

DRAWN BY

DESIGNED BY

CHECKED BY

APPROVED BY

PROJECT TITLE

DRAWN TITLE

SCALE

1

1/25

1

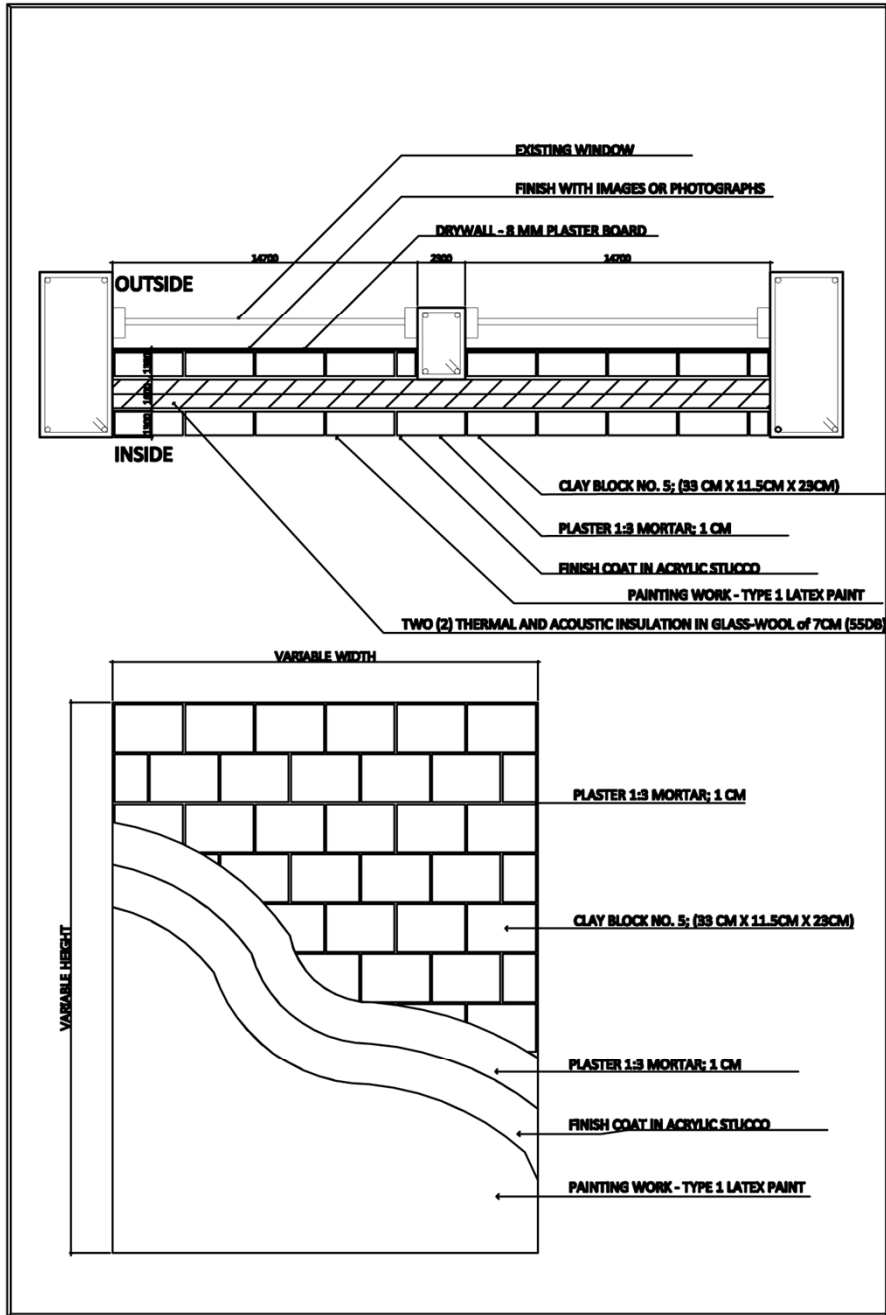

DET. 3

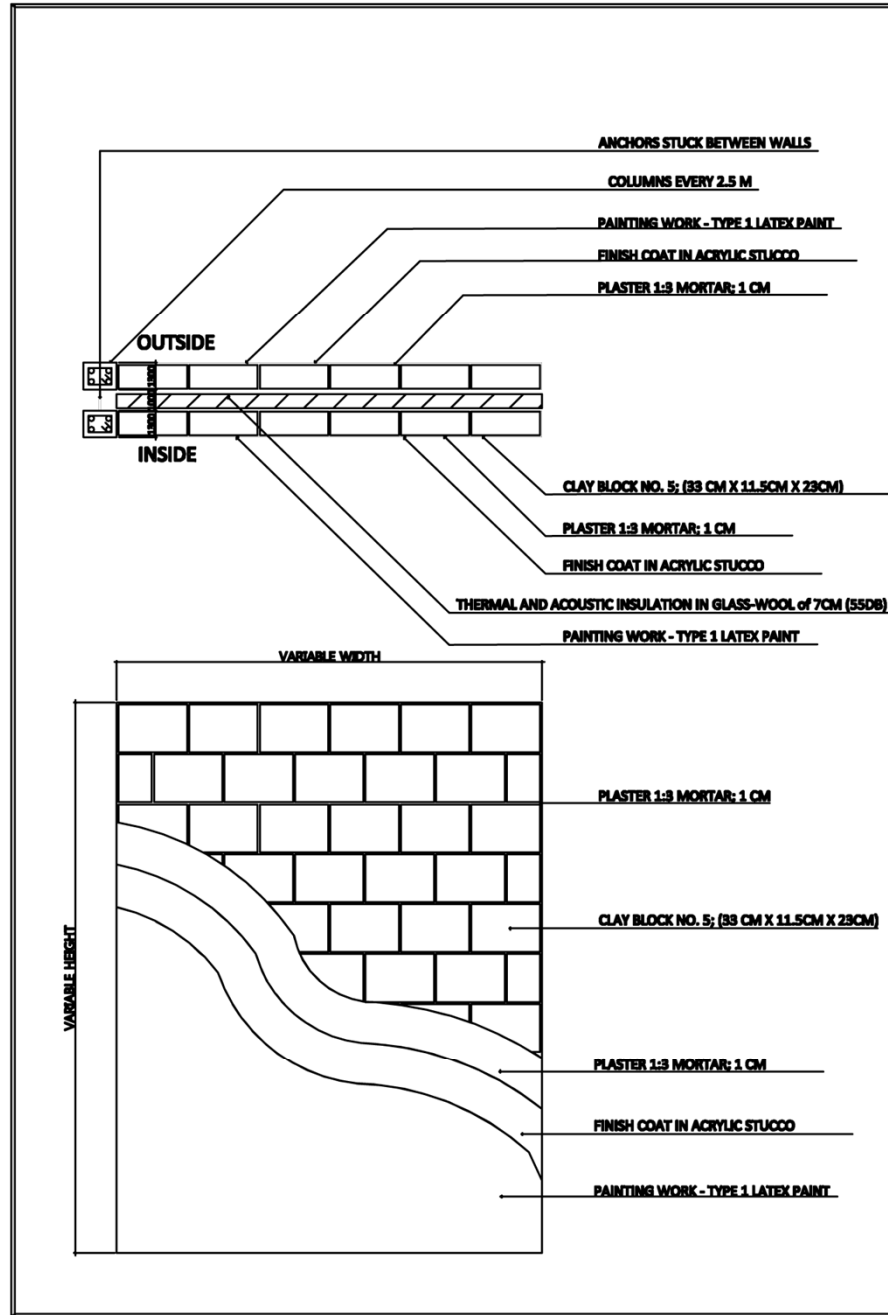

DET. 4

NOTE

DATE

DRAWN BY

DESIGNED BY

ENGINEER BY

APPROVED BY

PROJECT TITLE

DRAWN TITLE

SCALE

SHEET NO.
DRAWING NO.

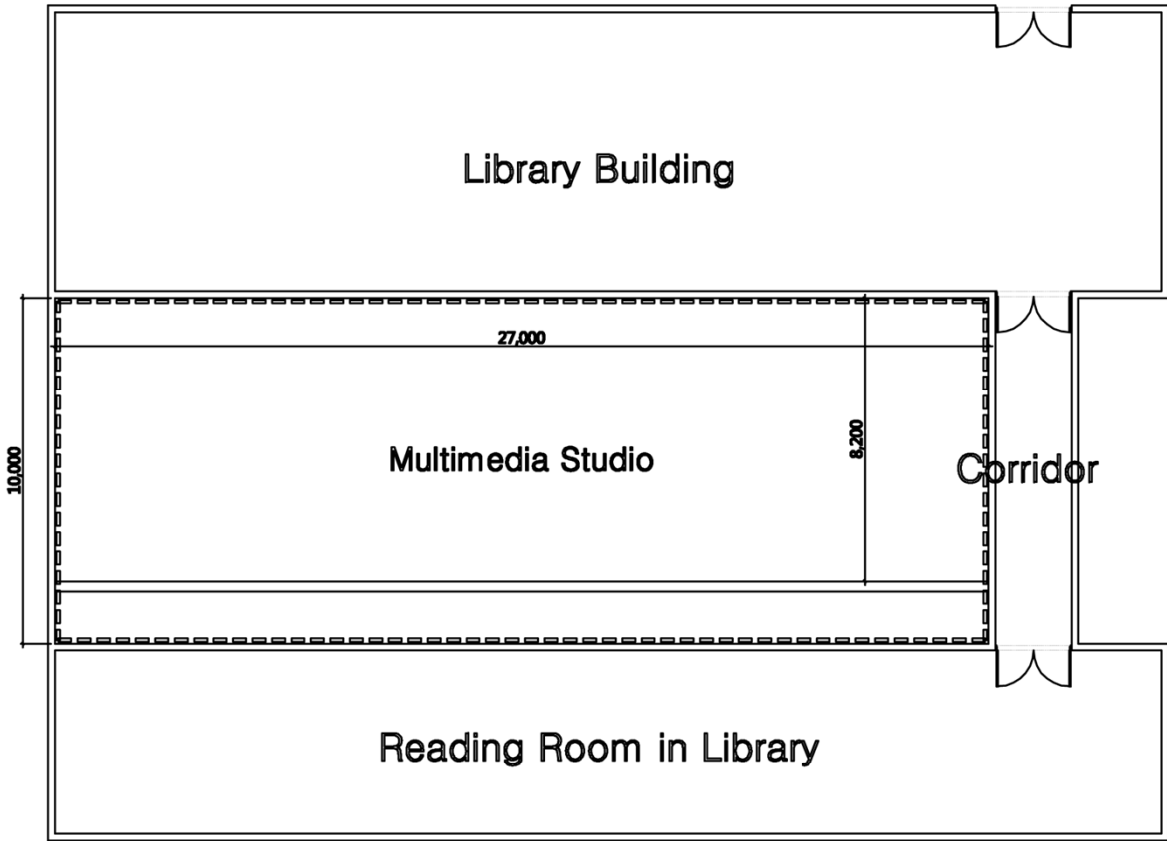

NOTE

DATE

DRAWN BY

DESIGNED BY

CHECKED BY

APPROVED BY

PROJECT TITLE

DRAWING TITLE

SCALE

SHEET NO.

DRAWING NO.

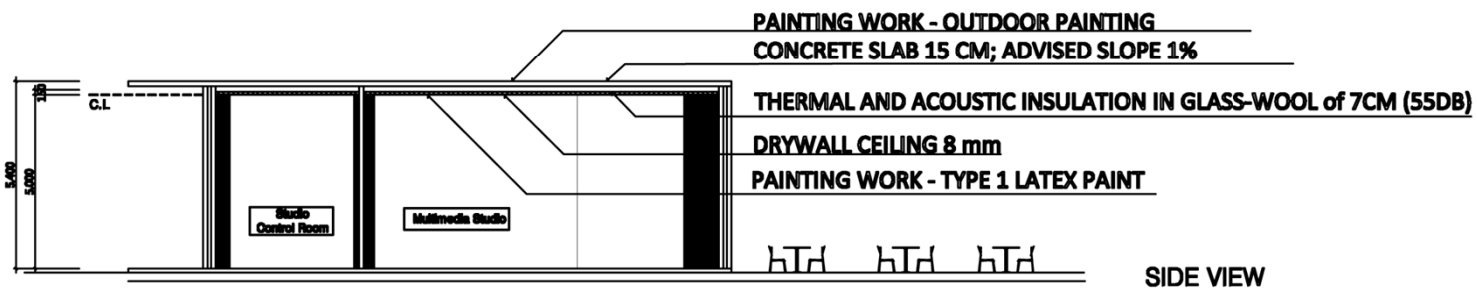
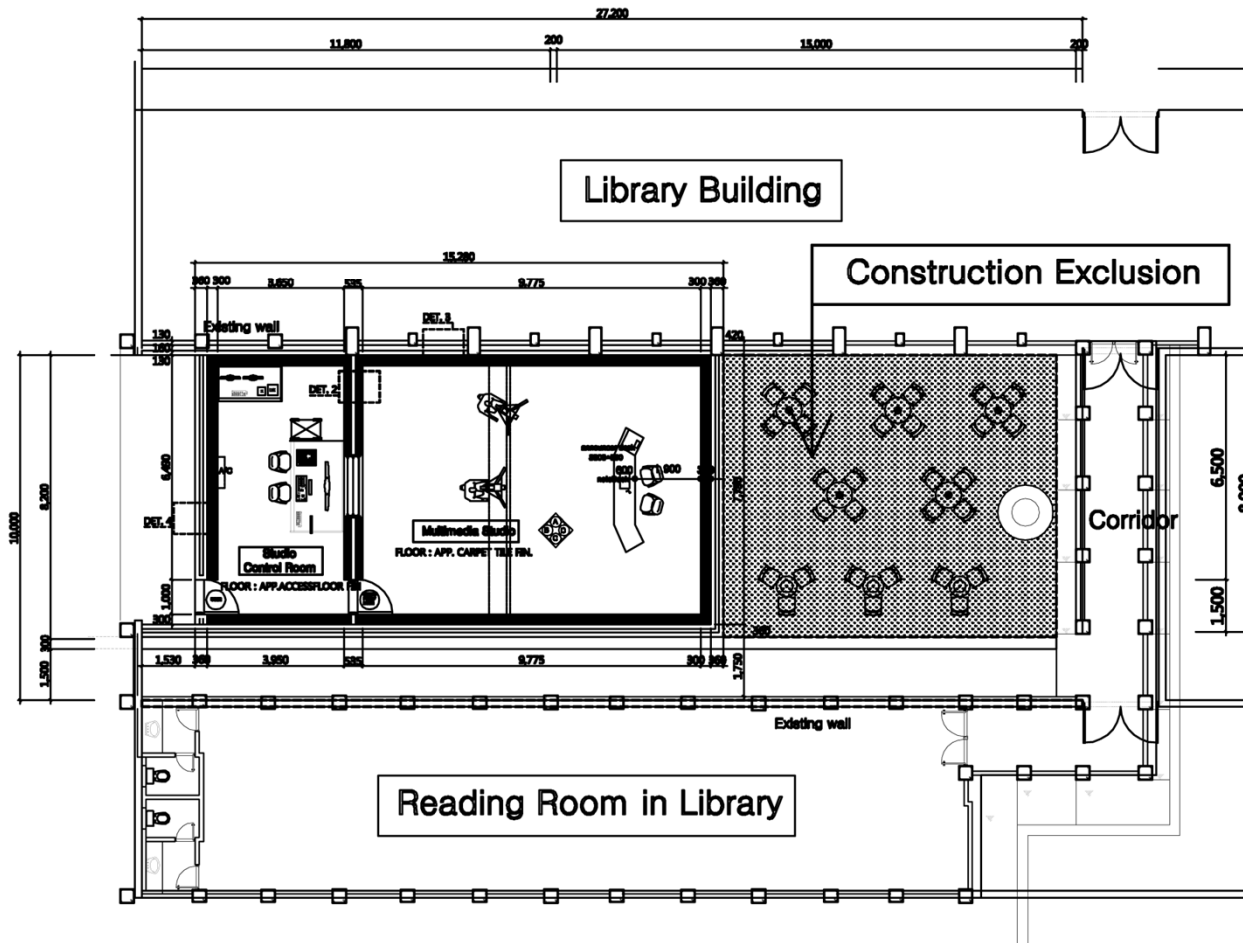

NOTE

DATE

DRAWN BY

DESIGNED BY

CHECKED BY

APPROVED BY

PROJECT TITLE

DRAWN TITLE

SCALE

SHEET NO.

DRAWN NO.

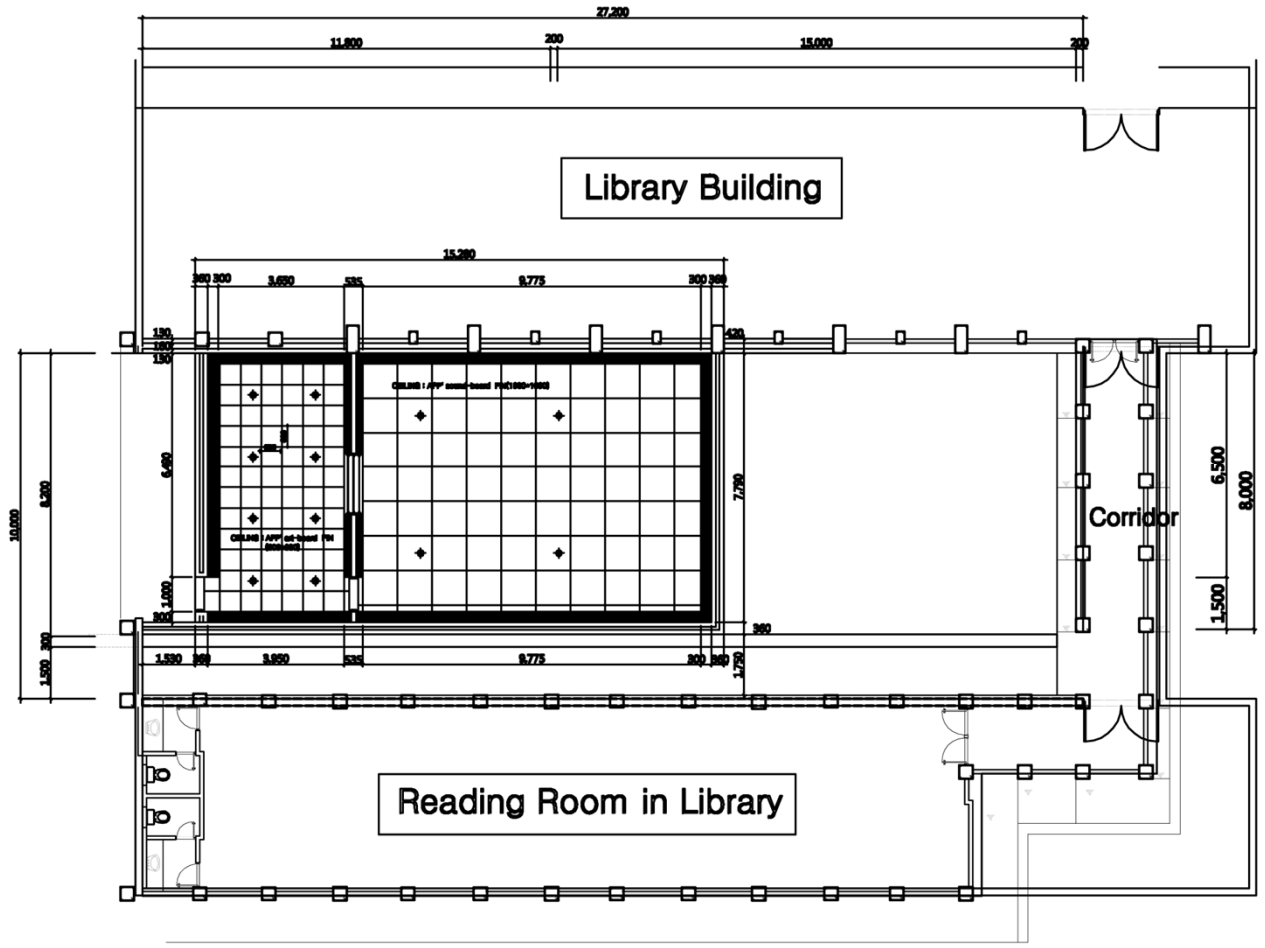

NOTE

DATE

DRAWN BY

DESIGNED BY

CHECKED BY

APPROVED BY

PROJECT TITLE

DRAWN TITLE

SCALE

SHEET NO.
DRAWN NO.

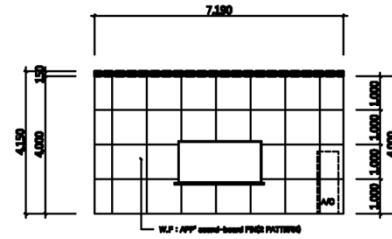
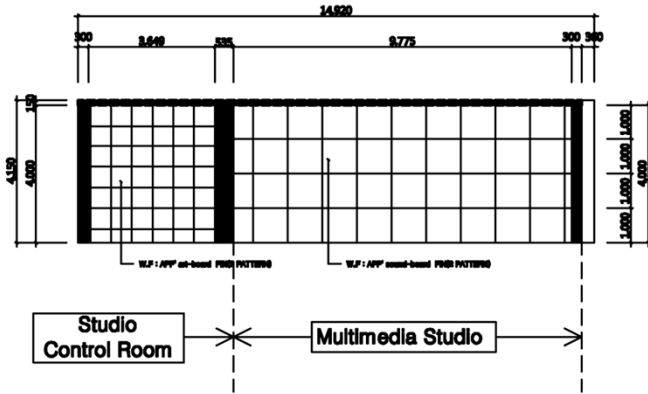

ELEVATION_A/B

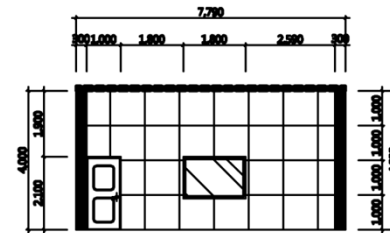
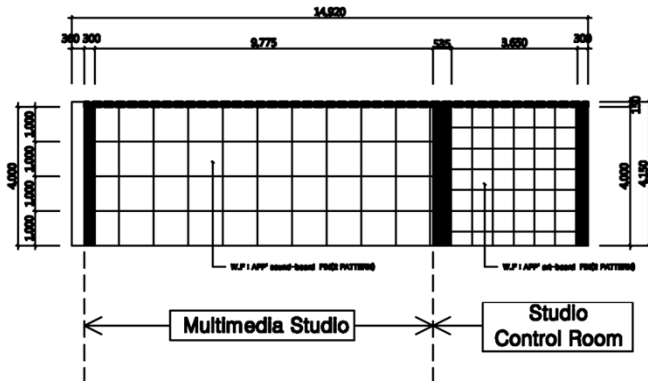

ELEVATION_C/D

NOTE

DATE

DRAWN BY

DESIGNED BY

CHECKED BY

APPROVED BY

PROJECT TITLE

DRAWN TITLE

SCALE

SHEET NO.
DRAWN NO.

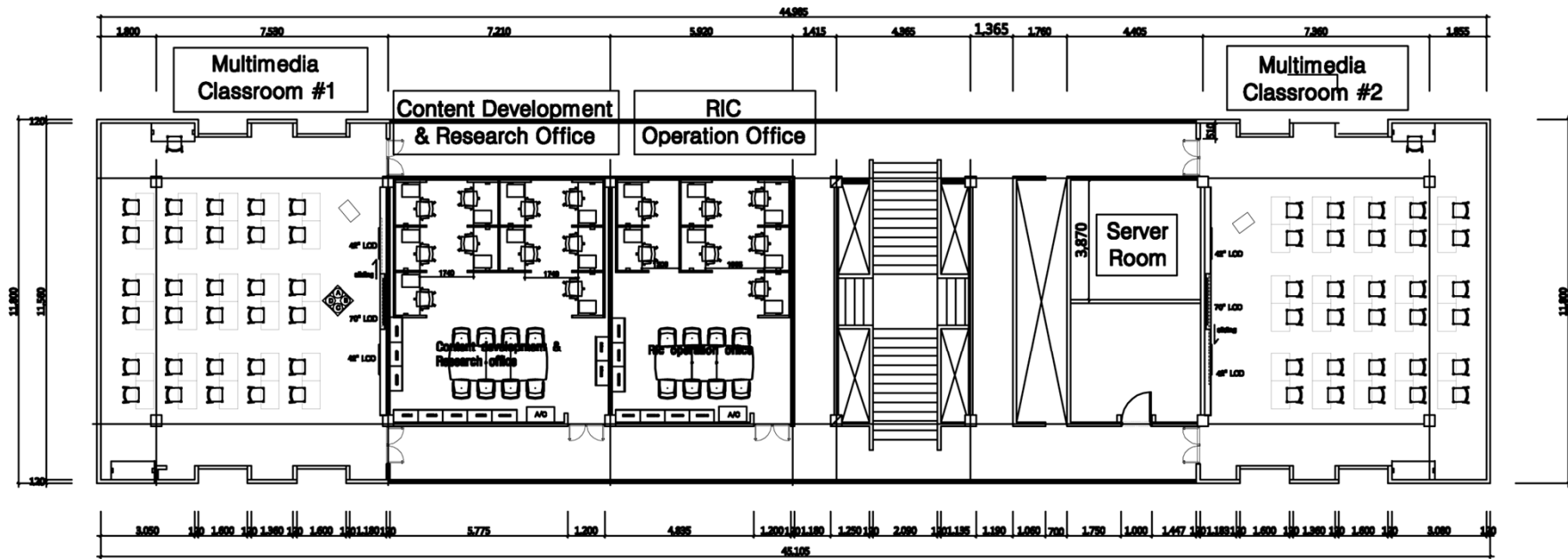
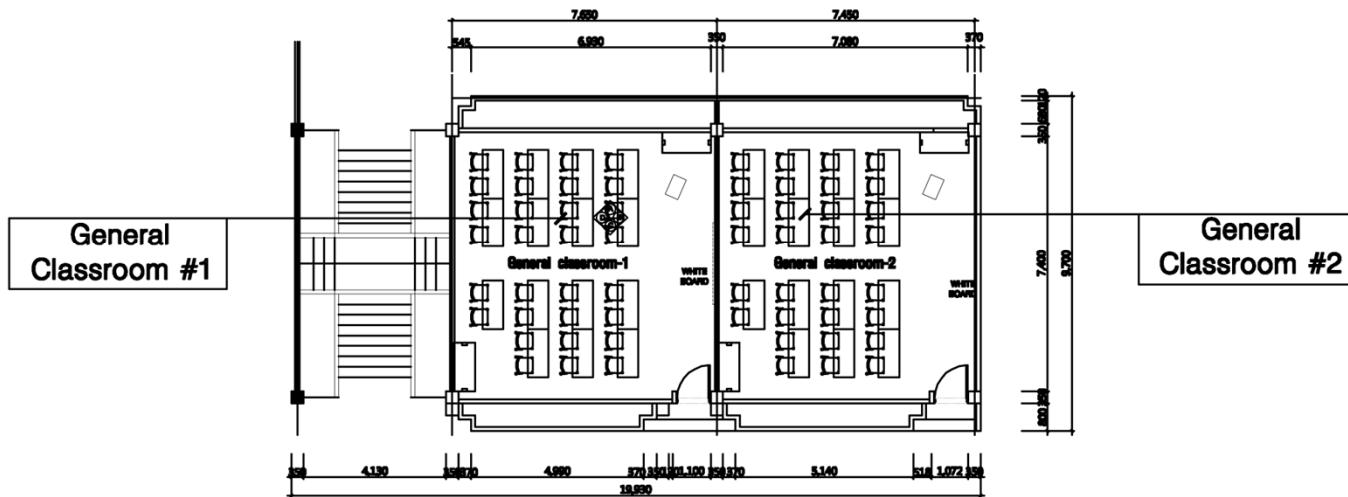

NOTE

DATE

DRAWN BY

DESIGNED BY

CHECKED BY

APPROVED BY

PROJECT TITLE

DRAWN TITLE

SCALE

SHEET NO.

DRAWN NO.

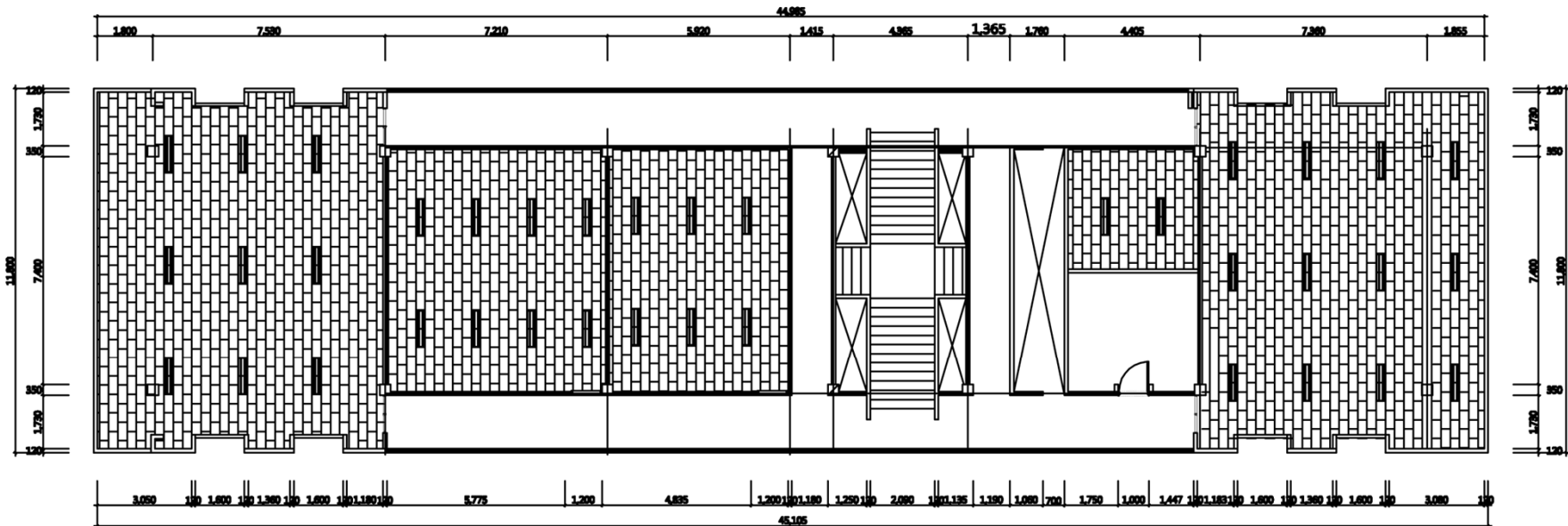
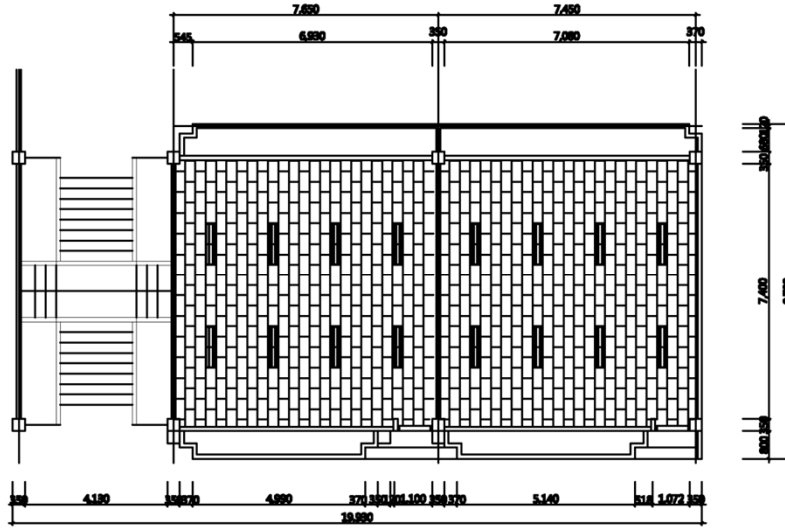

NOTE

DATE

DRAWN BY

DESIGNED BY

CHECKED BY

APPROVED BY

PROJECT TITLE

DRAWN TITLE

SCALE

SHEET NO.

DRAWN NO.

Universidad de Los Llanos_1st Ceiling Plan & 2nd Ceiling Plan

SCALE
1/150

1

General Classroom #1

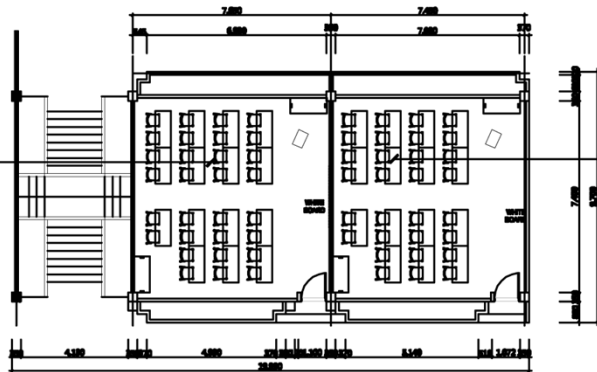

General Classroom #2

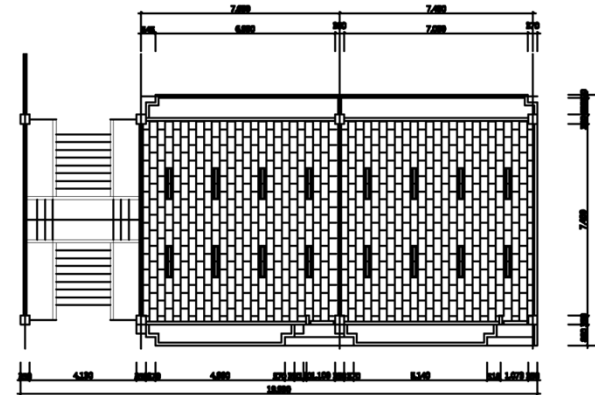

FLOOR PLAN

CEILING PLAN

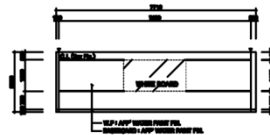
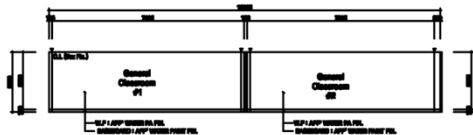

ELEVATION_A/B

ELEVATION_C/D

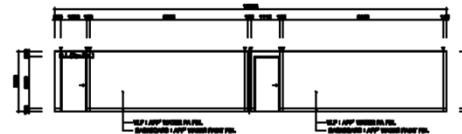

NOTE

DATE

DRAWN BY

DESIGNED BY

CHECKED BY

APPROVED BY

PROJECT TITLE

DRAWN TITLE

SCALE

SCALE
1/200

1

SHEET NO.
DRAWN NO.

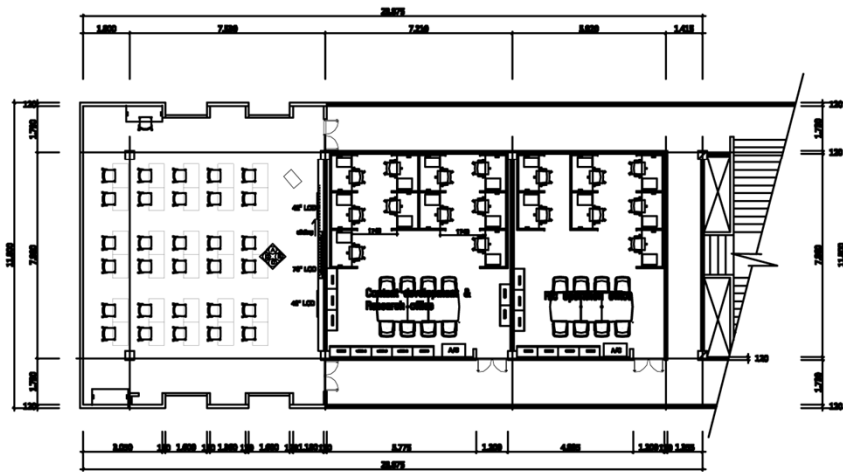

FLOOR PLAN

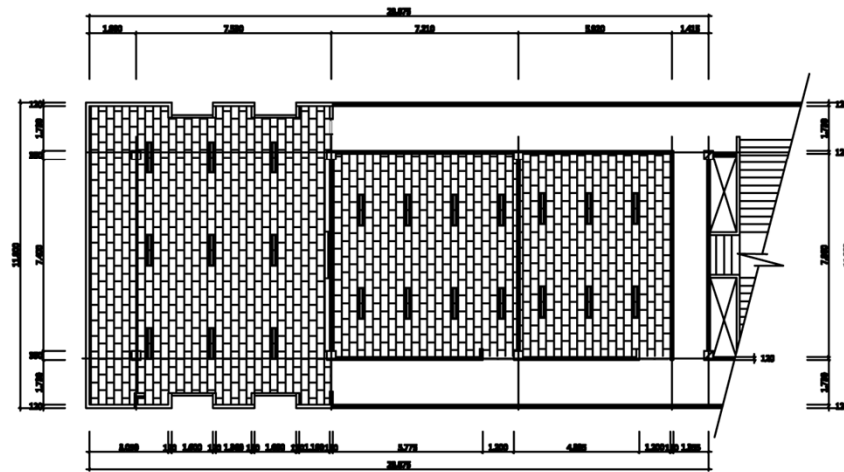

CEILING PLAN

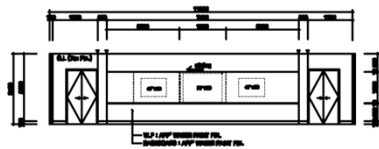
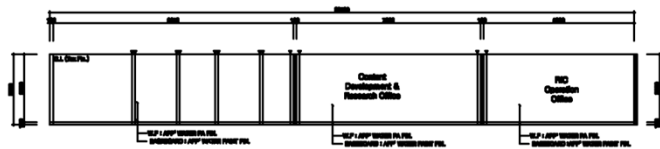

ELEVATION_A/B

ELEVATION_C/D

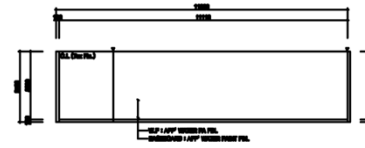
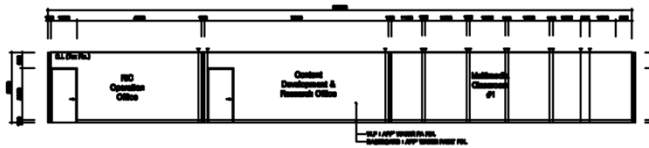

NOTE

DATE

DRAWN BY

DESIGNED BY

CHECKED BY

APPROVED BY

PROJECT TITLE

DRAWN TITLE

SCALE

SHEET NO.
DRAWN NO.

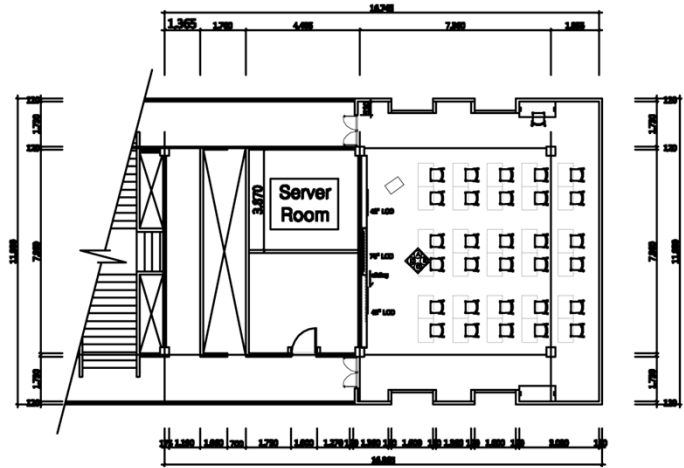

FLOOR PLAN

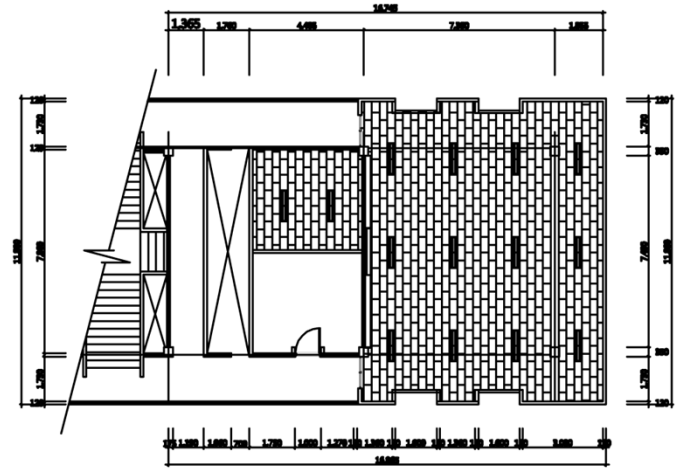

CEILING PLAN

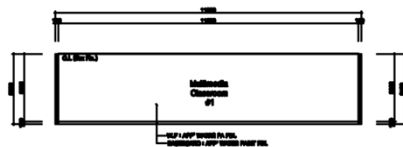
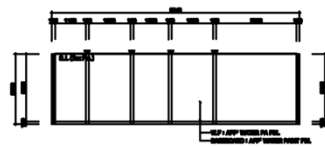

ELEVATION_A/B

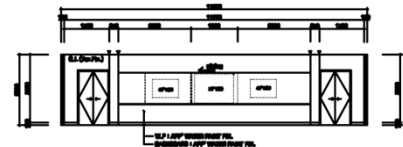
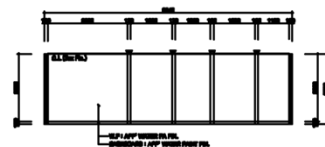

ELEVATION_C/D

NOTE

DATE

DRAWN BY

DESIGNED BY

CHECKED BY

APPROVED BY

PROJECT TITLE

DRAWN TITLE

SCALE

SHEET NO.

DRAWN NO.

3. Alianza Innovatic – Medellin

* Space information of the Debora Arango

RIC	Office	Building Name	Floor	Size(W X D X H)	Remark
Alianza Innovatic (Medellin)	RIC Operation Office	Debora Arango	1 st Floor	10.0 X 6.5 X 4.8	
	Multimedia Studio	Debora Arango	1 st Floor	5.6 X 16 X 4.8	
	Content Development and Research Office	Debora Arango	1 st Floor	7.2 X 13.6 X 4.8	
	Multimedia Classroom #1	Debora Arango	1 st Floor	9.8 X 5.7 X 3.3	
	Multimedia Classroom #2	Debora Arango	1 st Floor	9.9 X 5.7 X 3.3	
	General Classroom #1	Debora Arango	2 nd Floor	6.9 X 6.8 X 3.6	
	General Classroom #2	Debora Arango	2 nd Floor	9.8 X 5.7 X 3.6	
	Server Room	Debora Arango	1 st Floor	7 X 2.7 X 4.8	

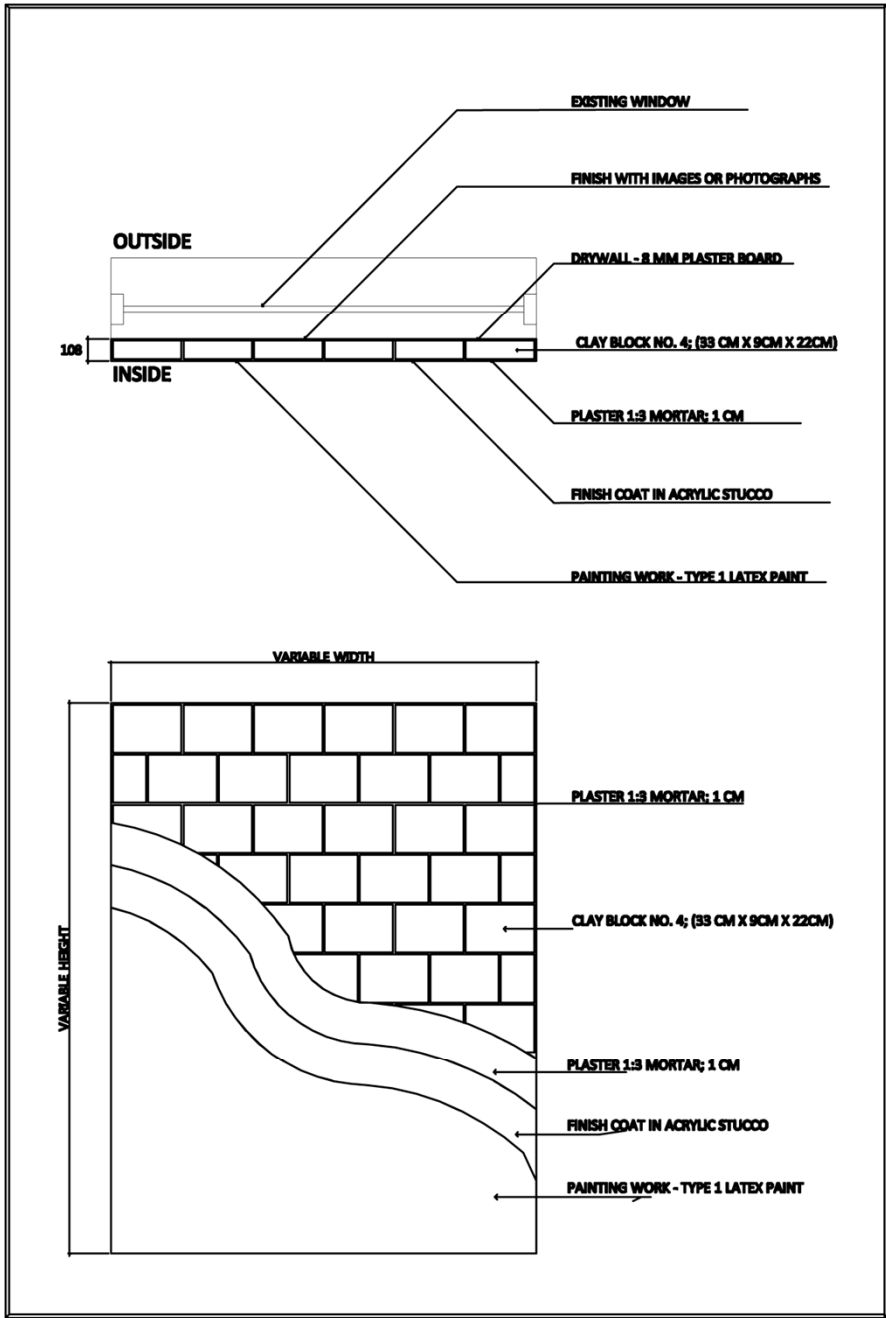

DET. 1

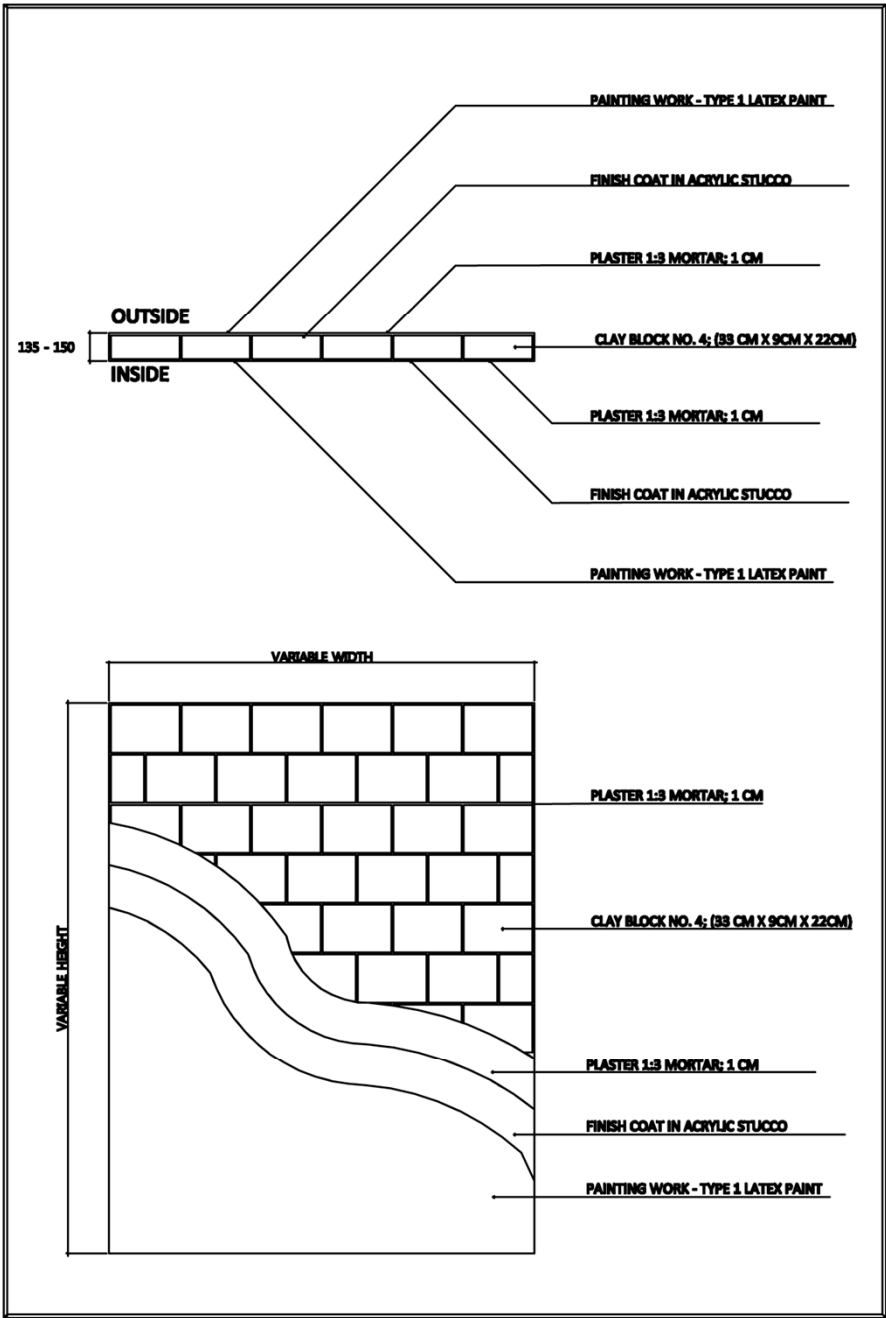

DET. 2

NOTE

DATE

DRAWN BY

DESIGNED BY

ORDERED BY

APPROVED BY

PROJECT TITLE

DRAWN TITLE

SCALE

SHEET NO.

DRAWN NO.

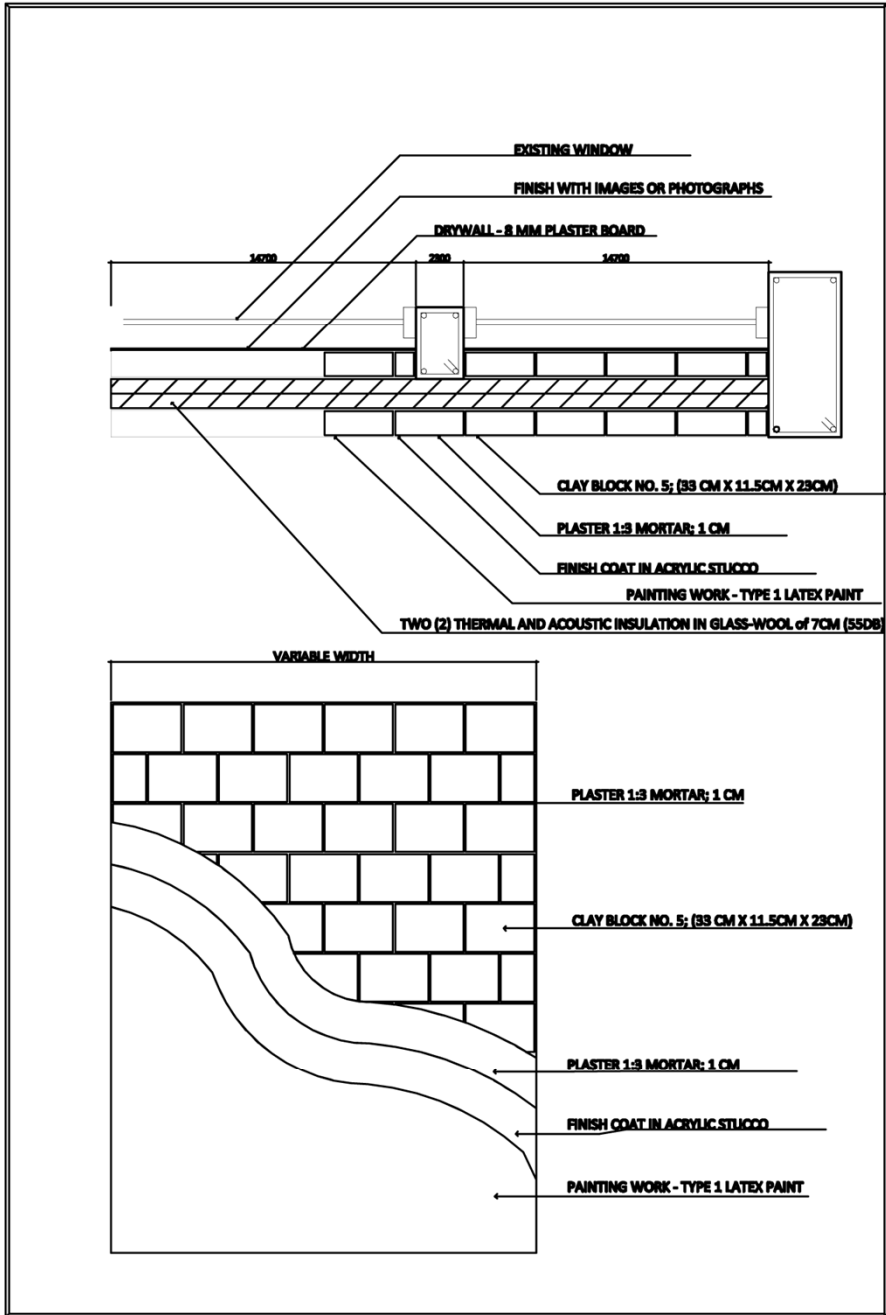

DET. 3

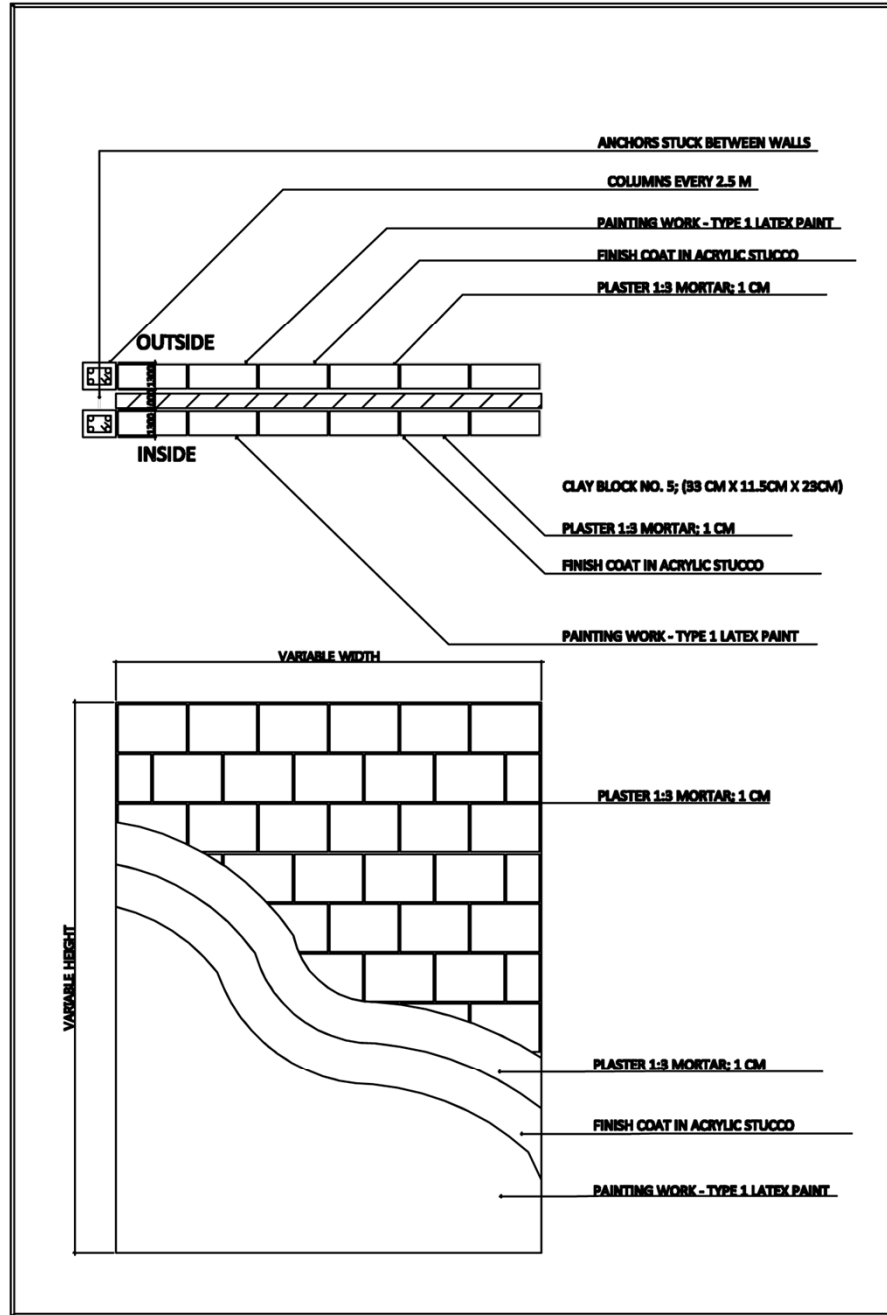

DET. 4

NOTE

DATE

DRAWN BY

DESIGNED BY

ORDERED BY

APPROVED BY

PROJECT TITLE

DRAWN TITLE

SCALE

SHEET NO.

DRAWN NO.

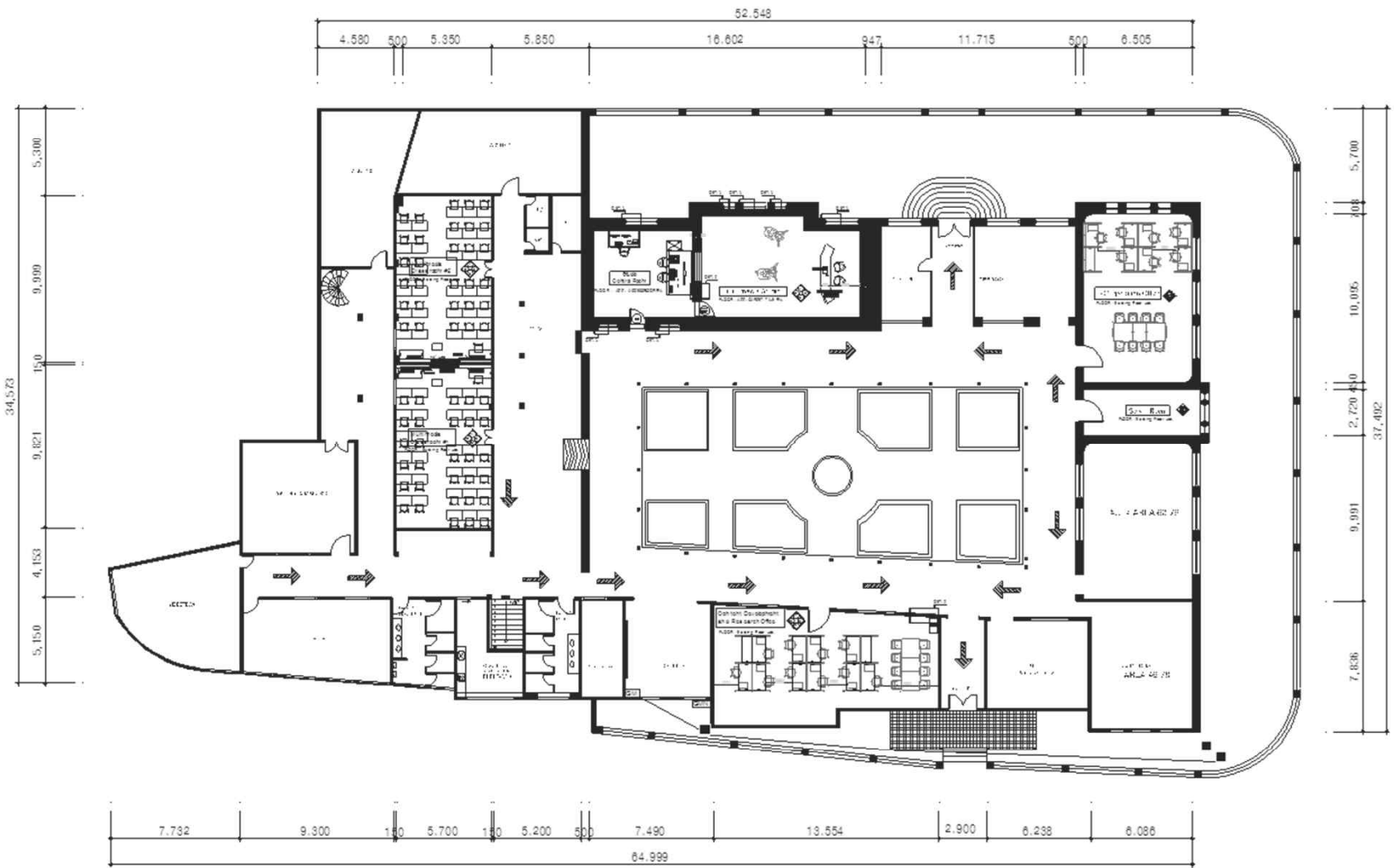

DATE	
DRAWN BY	
DESIGNED BY	
CHECKED BY	
APPROVED BY	
PROJECT TITLE	
DRAWING TITLE	
SCALE	
SHEET NO.	1
DRAWING NO.	

Debra Arango_1st Floor Plan

SCALE
1/280

1

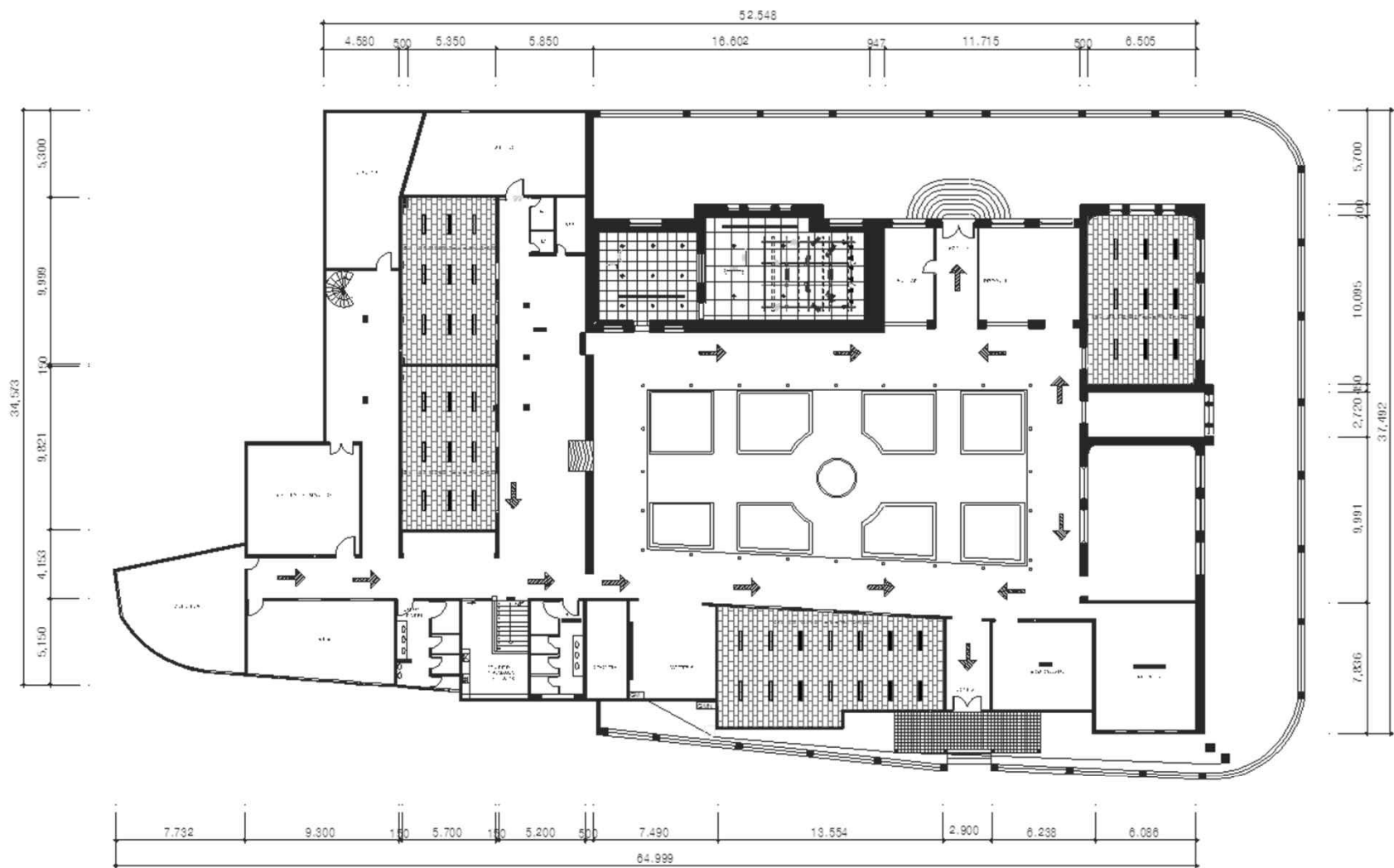

DATE	
DRAWN BY	
CHECKED BY	
APPROVED BY	
PROJECT TITLE	
DRAWN TITLE	
SCALE	
SHEET NO	1
DRAWING	

Debora Arango_1 *Ceiling Plan

SCALE
1/250

1

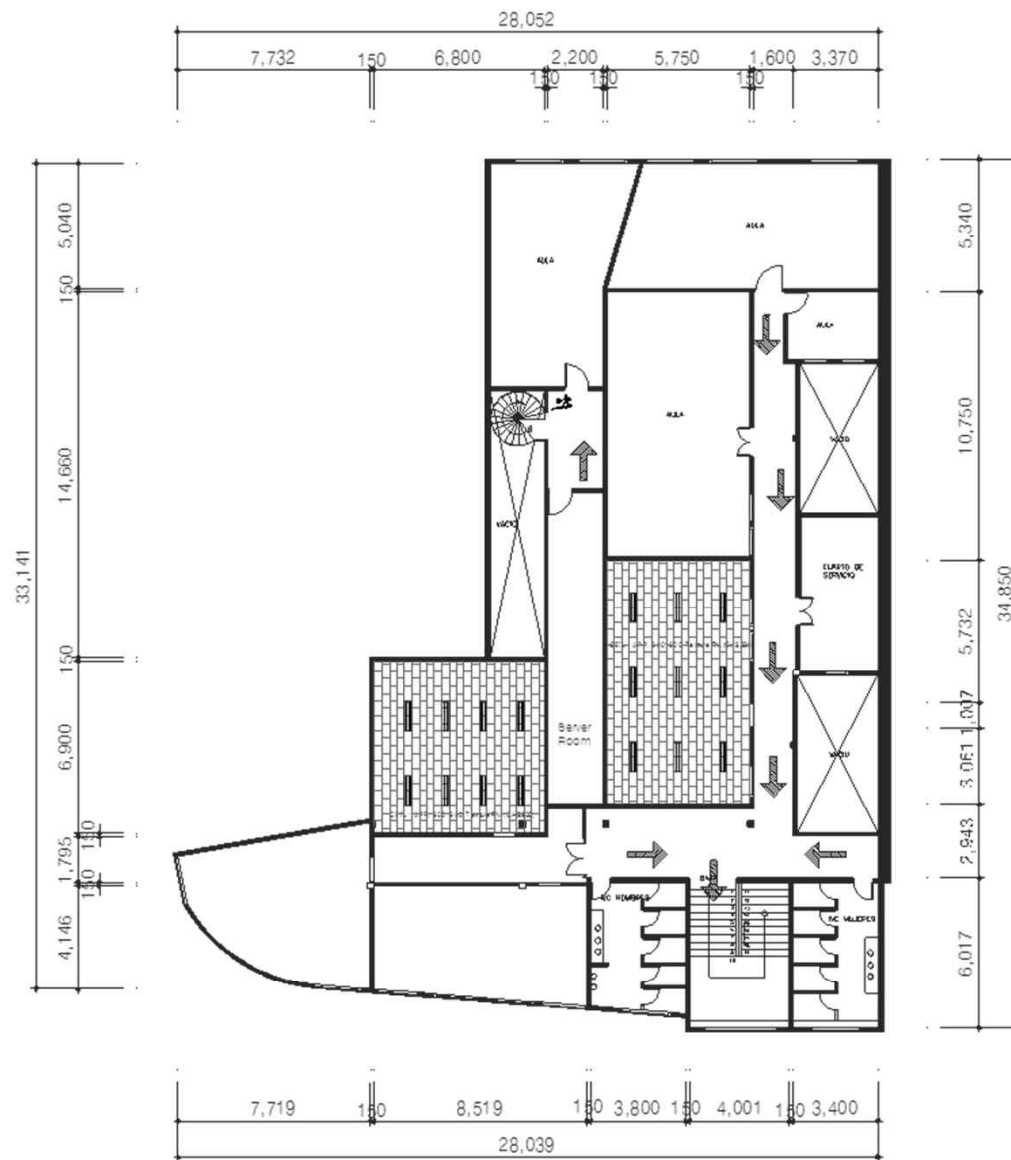

Debora Arango_2ª Ceiling Plan

SCALE
1/250

1

NOTE

DATE

DRAWN BY

DESIGNED BY

CHECKED BY

APPROVED BY

PROJECT TITLE

QUANTITY

SCALE

SHEET NO

DRAWING

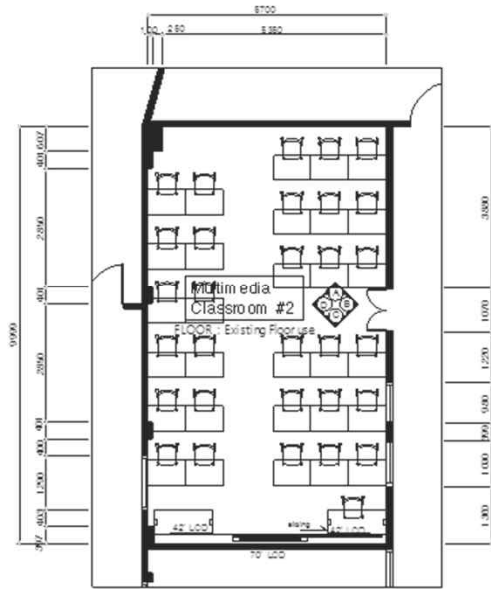

FLOOR PLAN

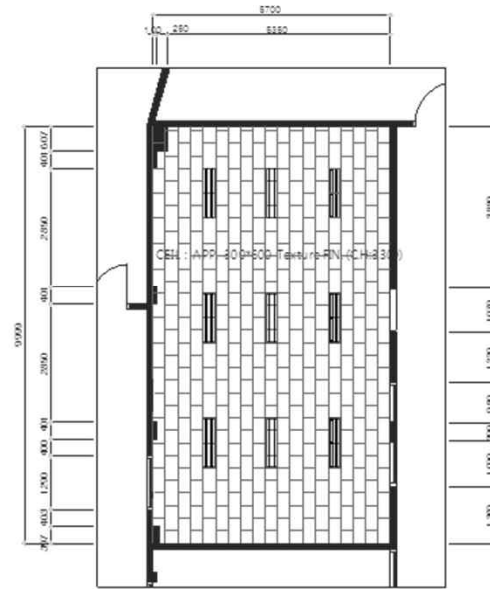

CEILING PLAN

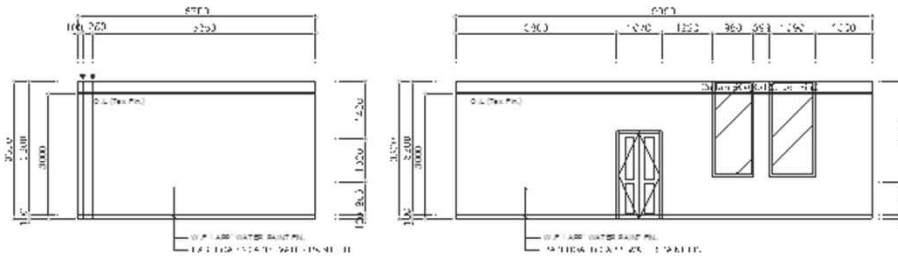

ELEVATION_A/B



ELEVATION_C/D

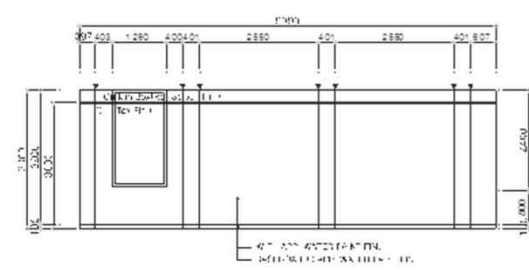

DATE	
DRAWN BY	
DESIGNED BY	
CHECKED BY	
APPROVED BY	
PROJECT TITLE	
DRAWING TITLE	
SCALE	
SHEET NO.	
DRAWING NO.	

Debora Arango_1st Floor Multimedia Classroom #2_Details

SCALE
1/150

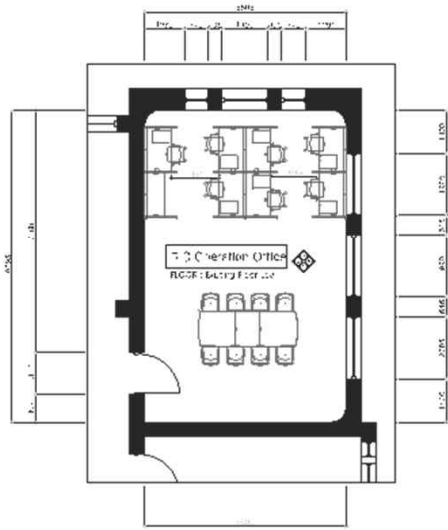

FLOOR PLAN

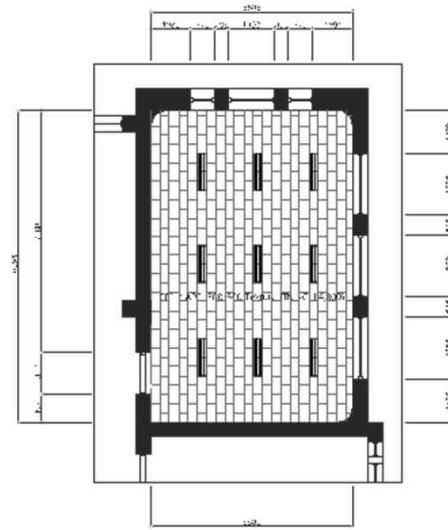

CEILING PLAN

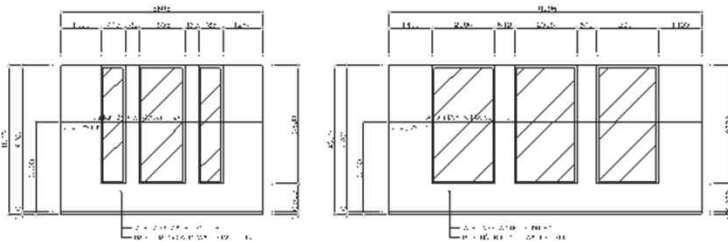

ELEVATION_A/B

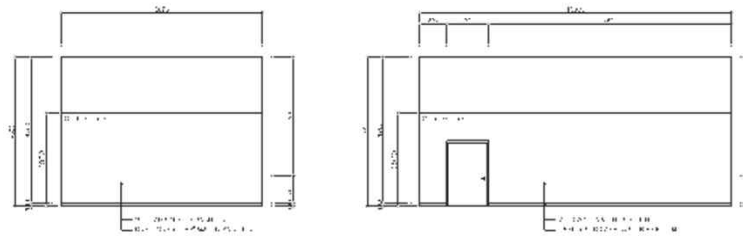

ELEVATION_C/D

DATE
DESIGNED BY
CHECKED BY
APPROVED BY
PROJECT TITLE
DATE PLOTTED
SCALE
SHEET NO
DRAWING

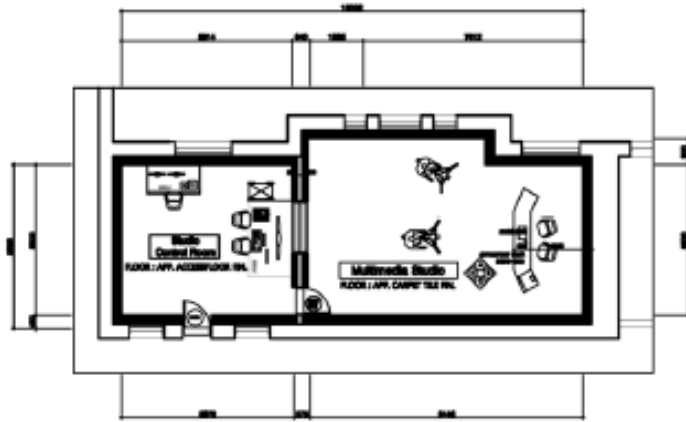

FLOOR PLAN

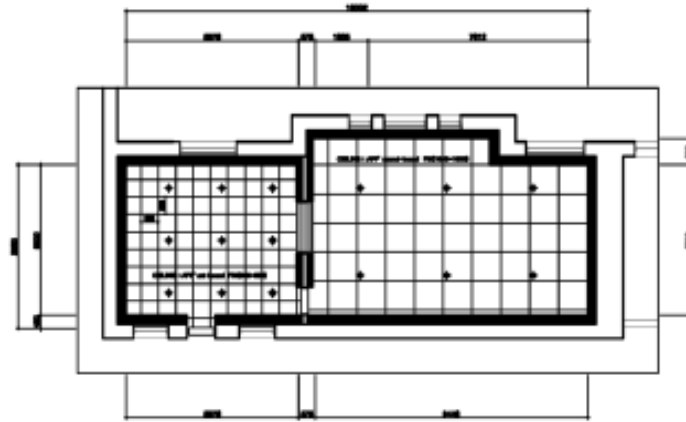

CEILING PLAN

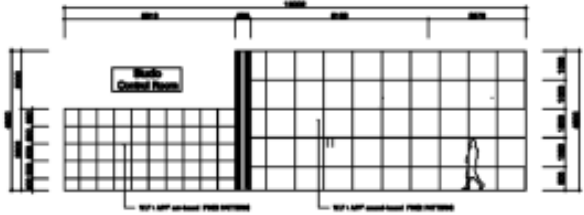

ELEVATION_A/B

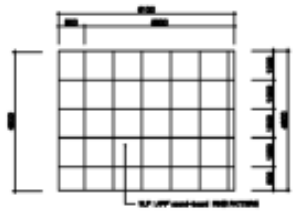

ELEVATION_C/D

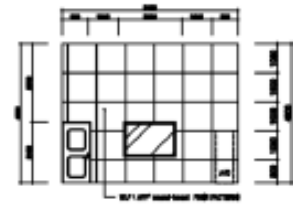
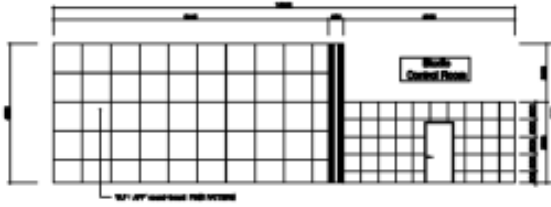

NOTE

DATE

DRAWN BY

DESIGNED BY

CHECKED BY

APPROVED BY

PROJECT TITLE

DRAWN TITLE

SCALE

SHEET NO.

DRAWN NO.

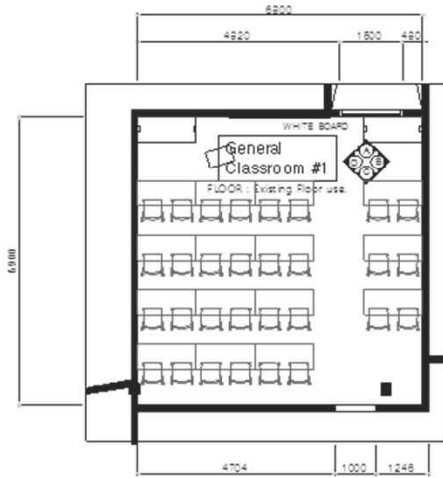

FLOOR PLAN

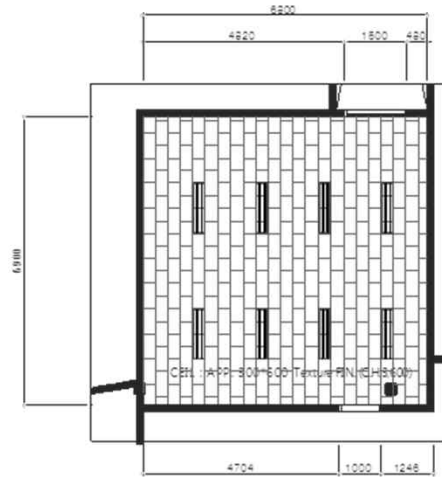

CEILING PLAN

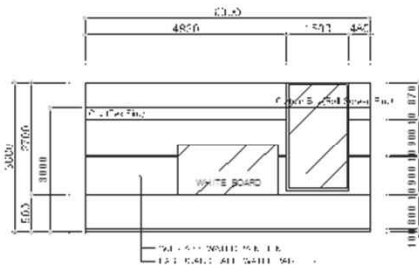

ELEVATION_C/D

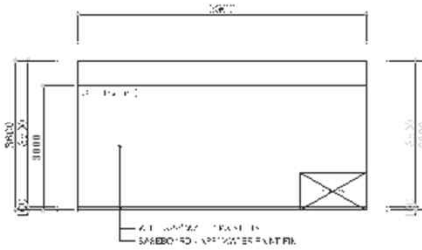

ELEVATION_A/B

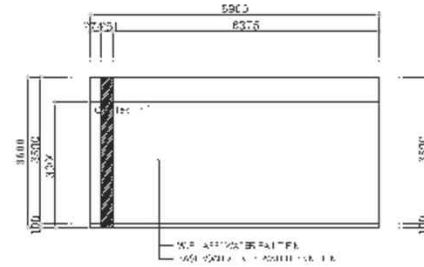
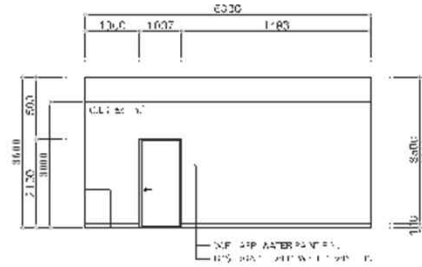

DATE
DESIGNER
DRAWN BY
CHECKED BY
APPROVED BY
PROJECT TITLE
ROOM TITLE
SCALE
SHEET NO.
DRAWING



FLOOR PLAN

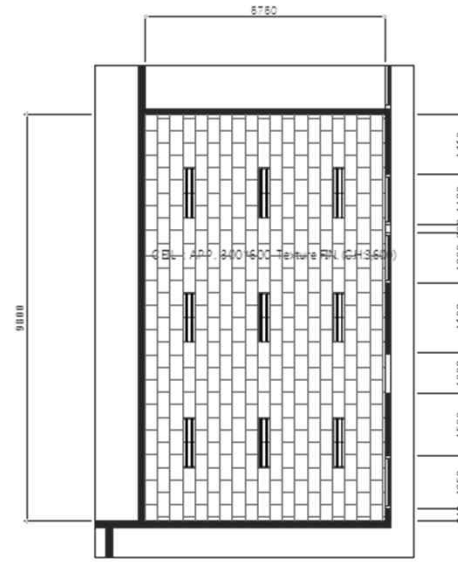

CEILING PLAN

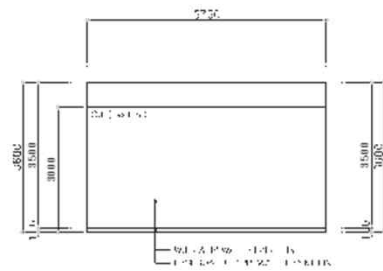

ELEVATION_C/D

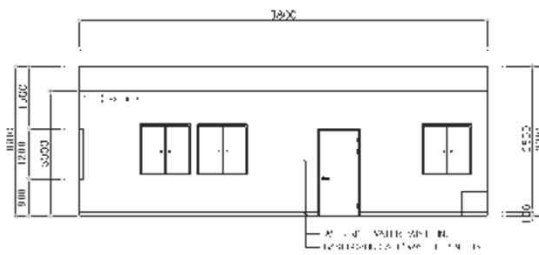

ELEVATION_A/B

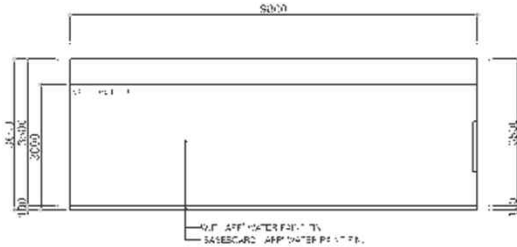
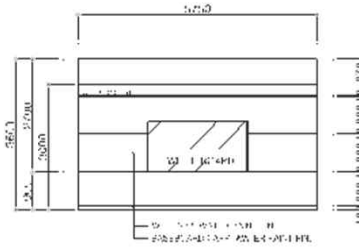

DATE
DRAWN BY
DESIGNED BY
CHECKED BY
APPROVED BY
PROJECT TITLE
DRAWING TITLE
SCALE
SHEET NO
DRAWING

4. Alianza Sur Occidente – Cali

**** Space information of the Universidad del Valle**

RIC	Office	Building Name	Floor	Size(W X D X H)	Remark
Alianza Sur Occidente (Cali)	RIC Operation Office	317 Building	2 nd Floor	6.6 X 4.4 X 2.8	
	Multimedia Studio	317 Building	1 st Floor & 2 nd Floor	11.3 X 8.0 X 6.7(Studio) 5.1 X 4.9 X 3.7(Control Room)	
	Content Development and Research Office	317 Building	1 st Floor	6.6 X 9.6 X 2.8	
	Multimedia Classroom #1	317 Building	1 st Floor	10.8 X 6.2 X 2.7	
	Multimedia Classroom #2	317 Building	1 st Floor	10.8 X 5.9 X 2.7	
	General Classroom #1	317 Building	1 st Floor	7.0 X 6.9 X 2.7	
	General Classroom #2	317 Building	1 st Floor	7 X 6.9 X 2.7	
	Server Room	317 Building	2 nd Floor		using the current server room

- The current server room on the second floor is to be utilized to accommodate new equipment. Space for 1 more Rack shall be provided in the room by Universidad del Valle.
- The Bidder shall provide a spiral staircase in multimedia studio.

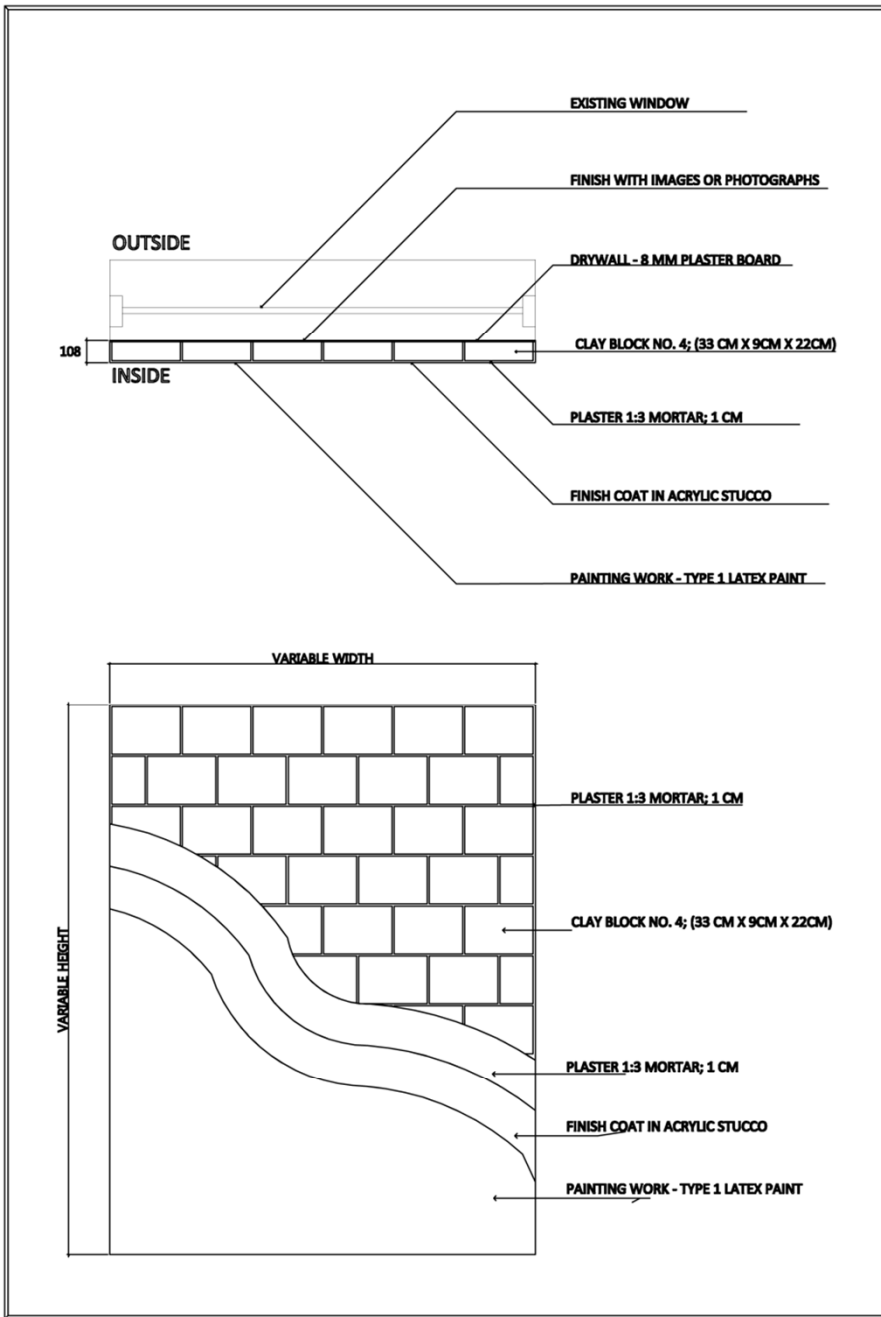

DET. 1

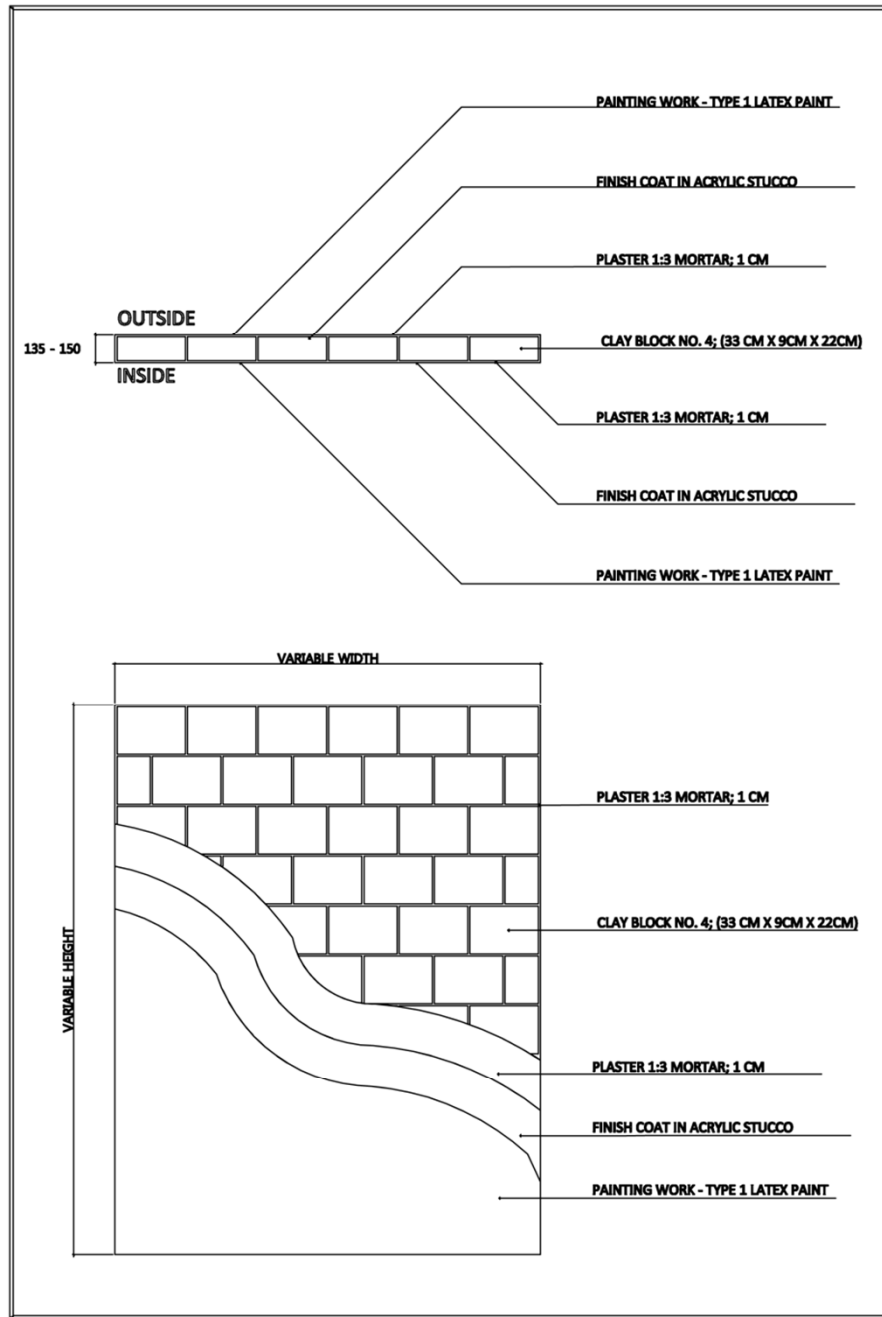

DET. 2

NOTE

DATE

DRAWN BY

DESIGNED BY

CHECKED BY

APPROVED BY

PROJECT TITLE

DRAWN TITLE

SCALE

SHEET NO.

DRAWN NO.

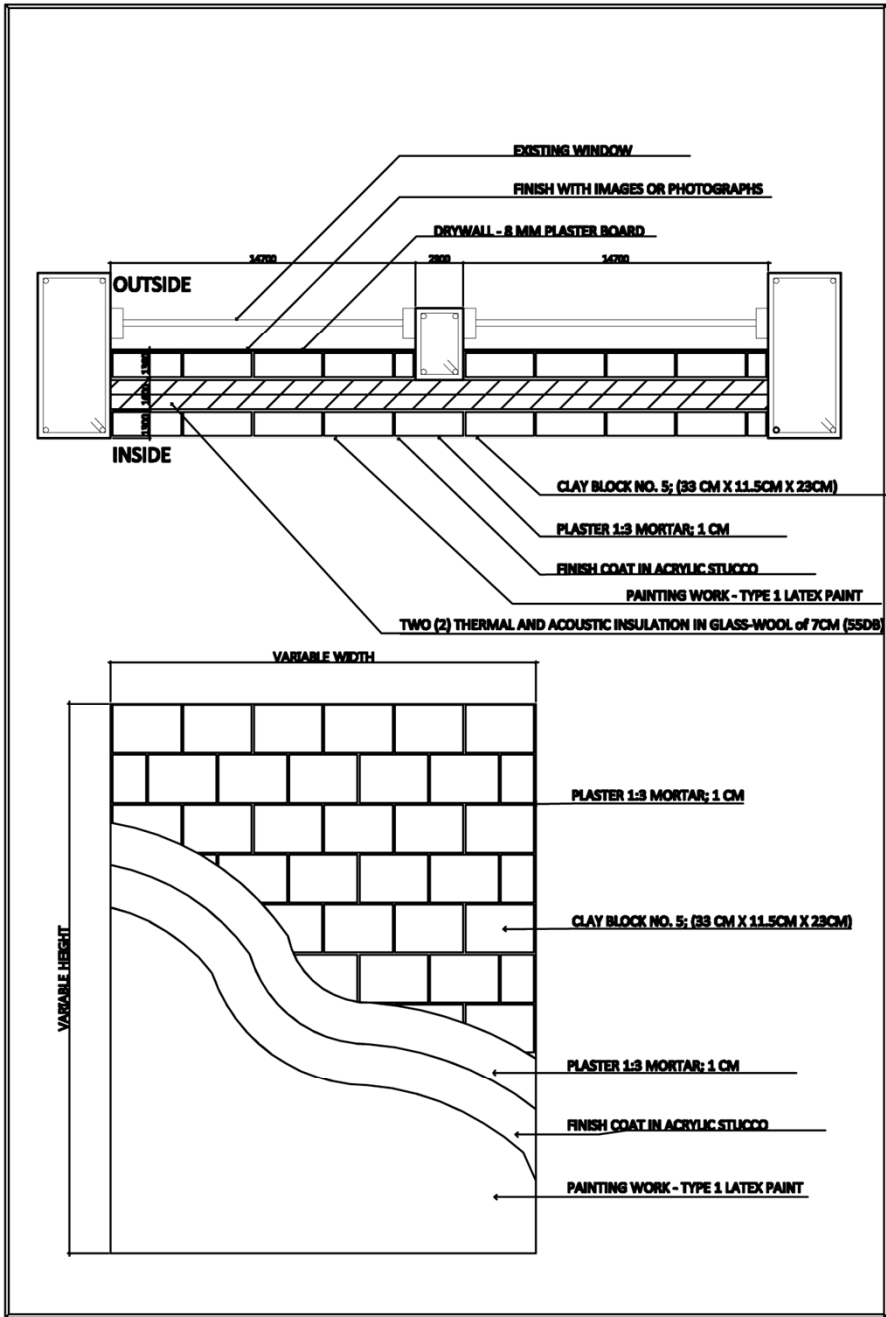

DET. 3

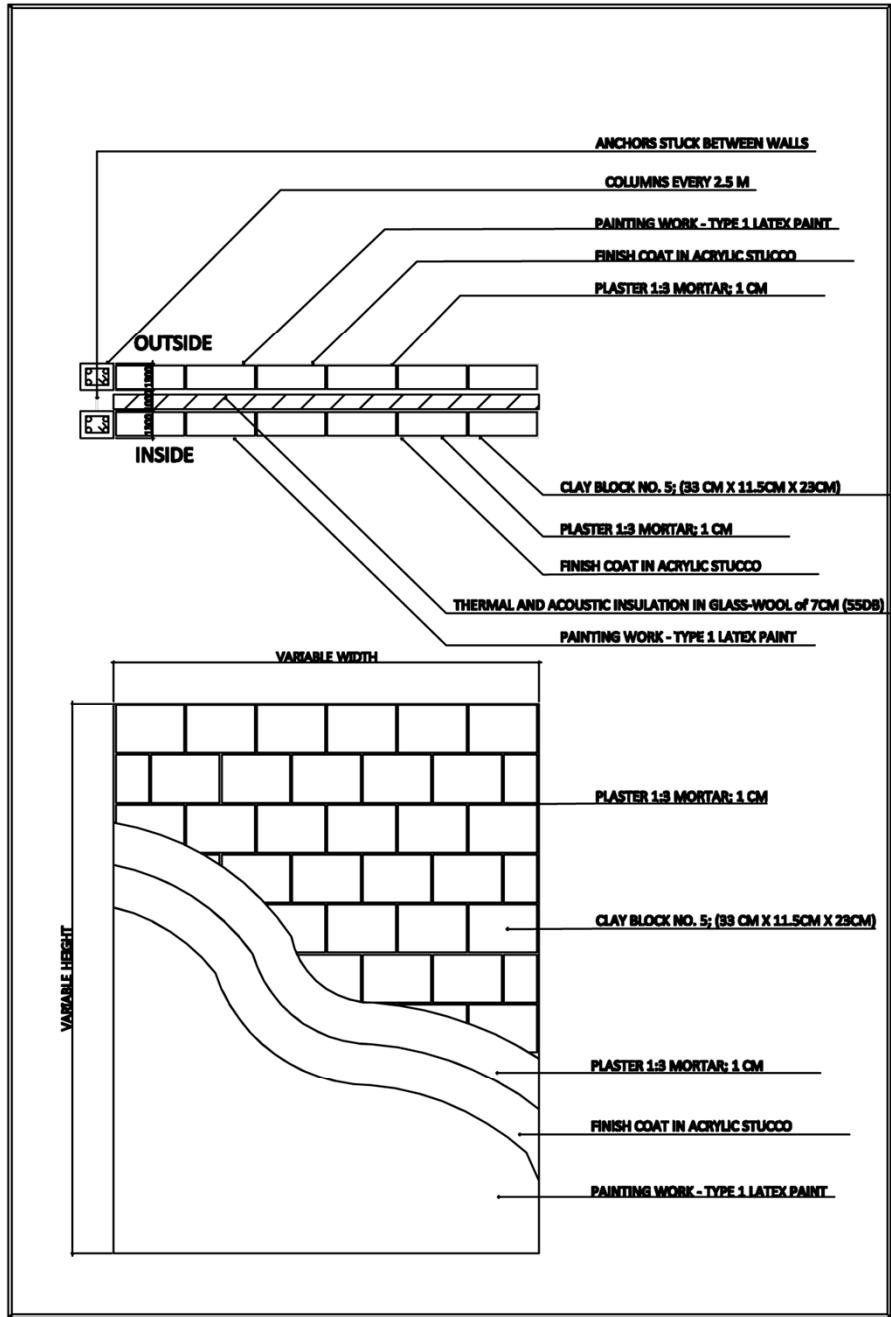

DET. 4

NOTE

DATE

DRAWN BY

DESIGNED BY

CHECKED BY

APPROVED BY

PROJECT TITLE

DRAWN TITLE

SCALE

SHEET NO.

DRAWN NO.

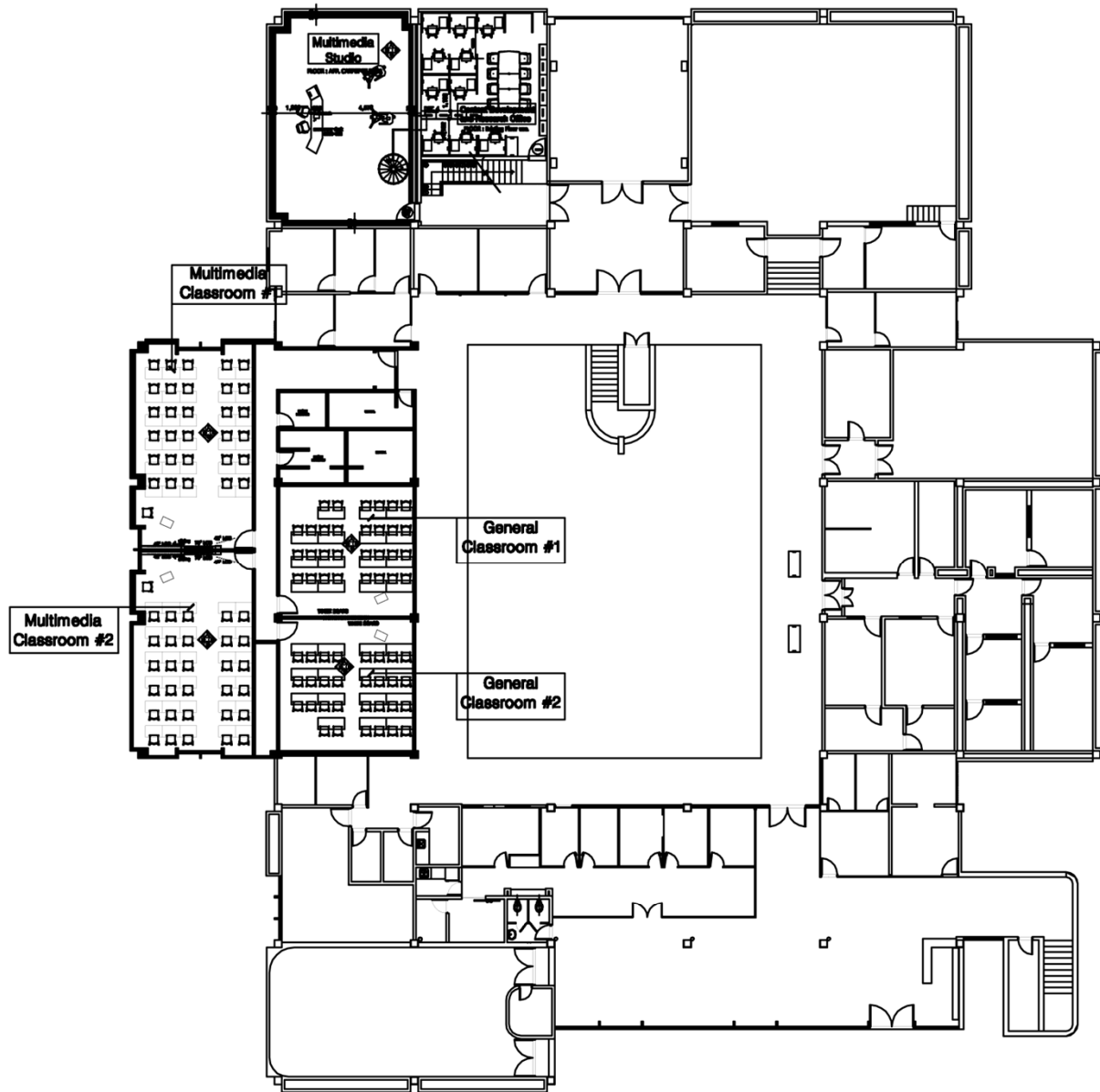

NOTE

DATE

DRAWN BY

DESIGNED BY

CHECKED BY

APPROVED BY

PROJECT TITLE

DRAWN TITLE

SCALE

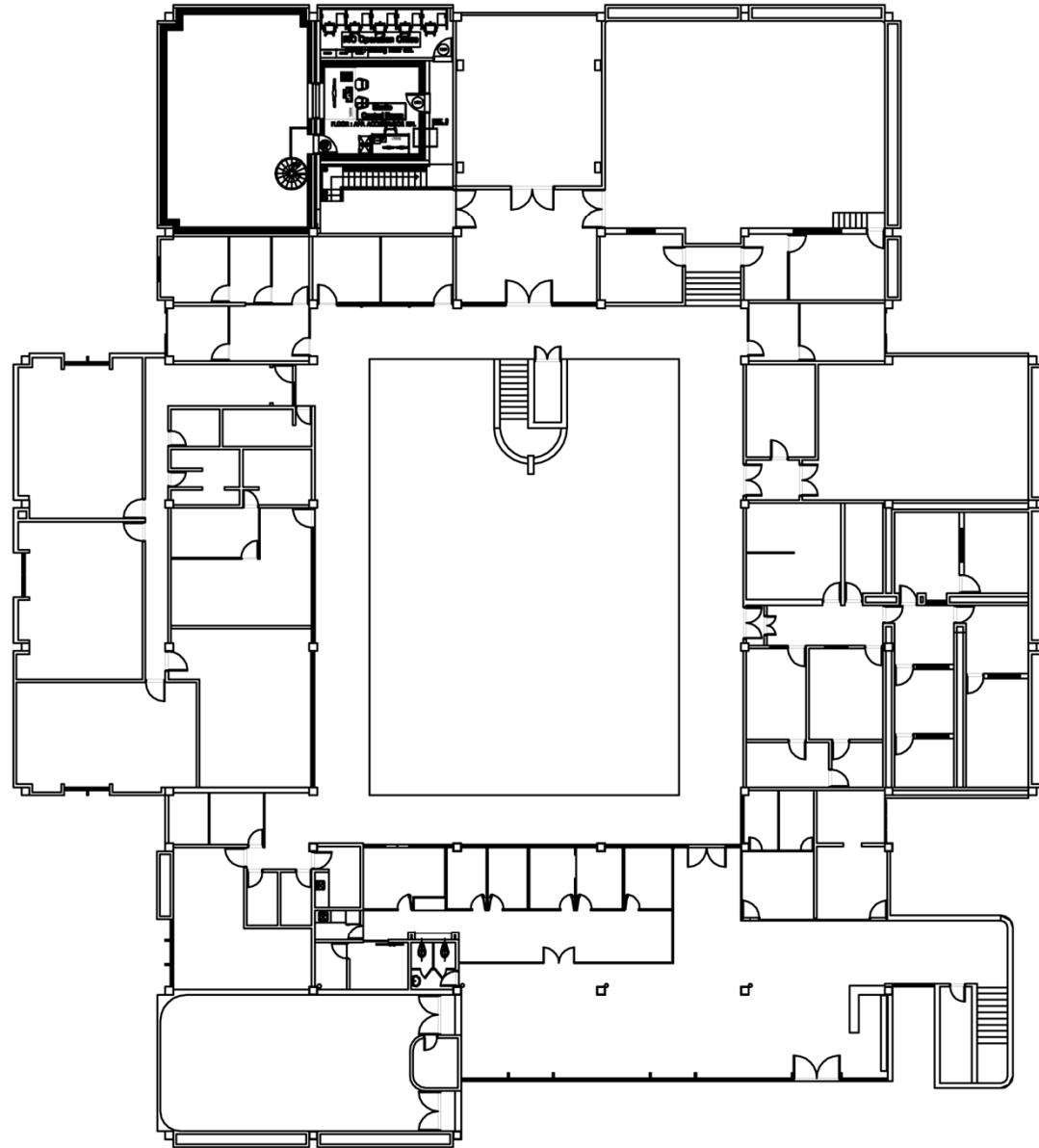

NOTE

DATE

DRAWN BY

DESIGNED BY

CHECKED BY

APPROVED BY

PROJECT TITLE

DRAWN TITLE

SCALE

SHEET NO.

DRAWN NO.

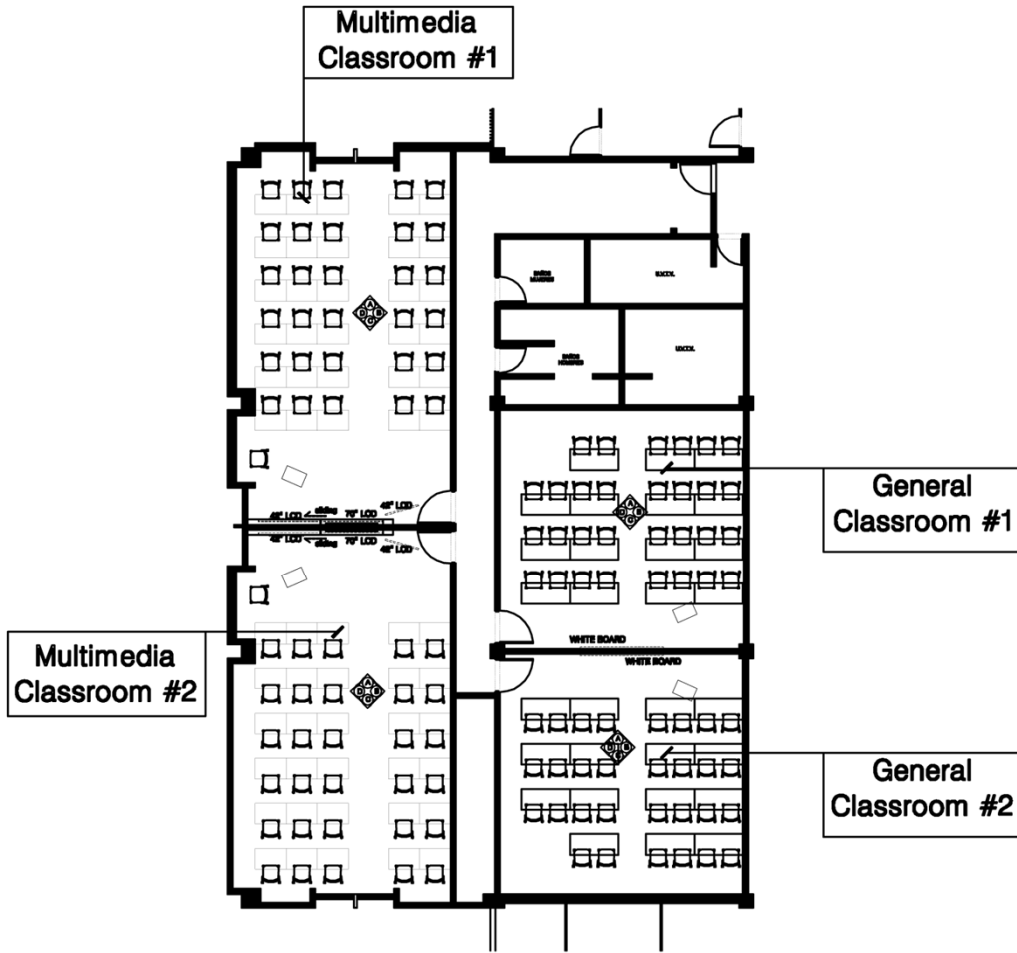

1st FLOOR of the 317 Building
SCALE:1/150

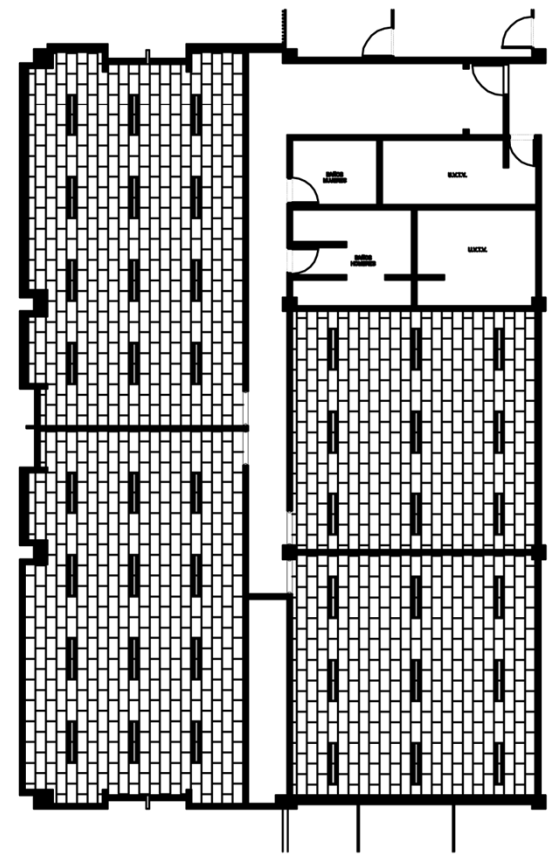

1st CEILING of the 317 Building
SCALE:1/150

NOTE

DATE

DRAWN BY

DESIGNED BY

CHECKED BY

APPROVED BY

PROJECT TITLE

DRAWN TITLE

SCALE

SHEET NO.
DRAWN NO.

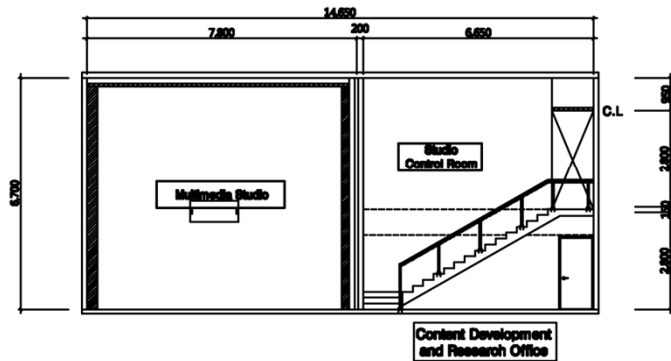
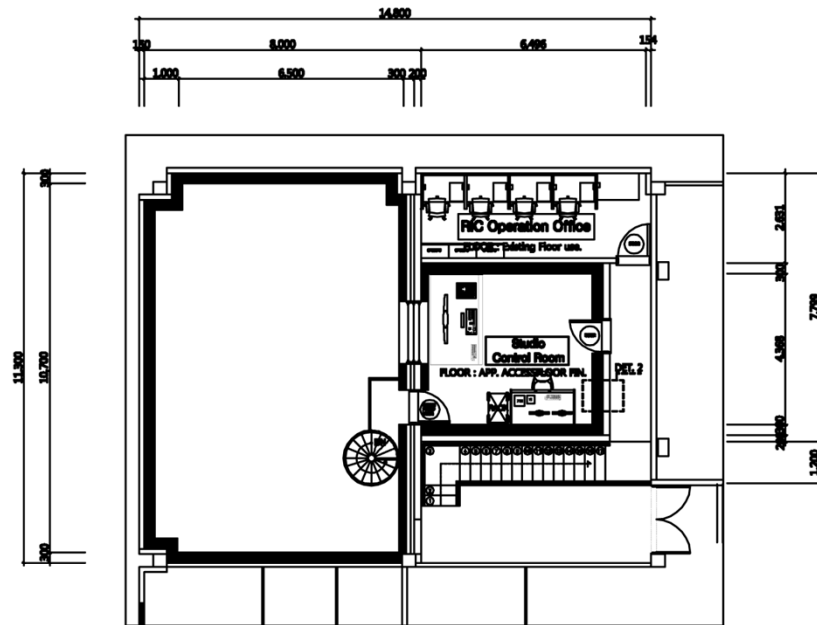
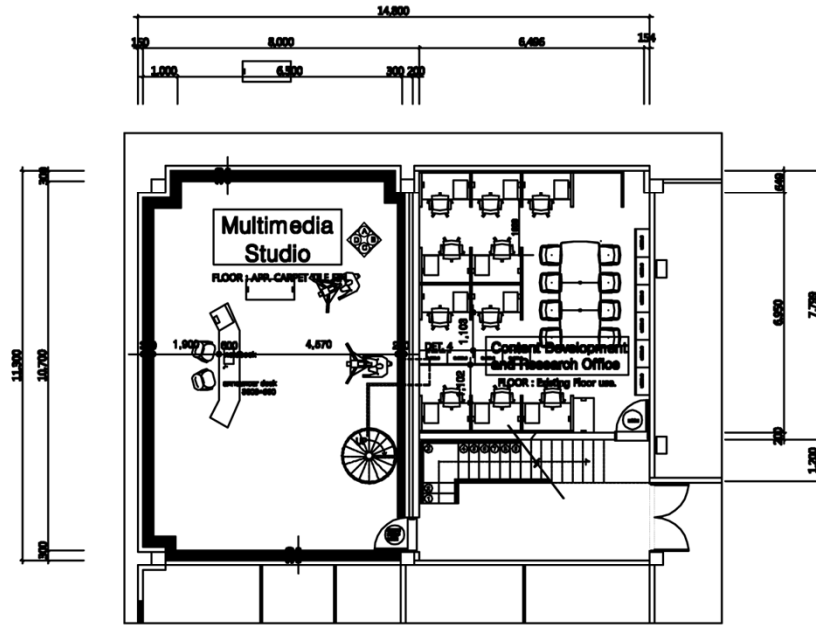

NOTE

DATE

DRAWN BY

DESIGNED BY

CHECKED BY

APPROVED BY

PROJECT TITLE

DRAWN TITLE

SCALE

SHEET NO.
DRAWN NO.

1F

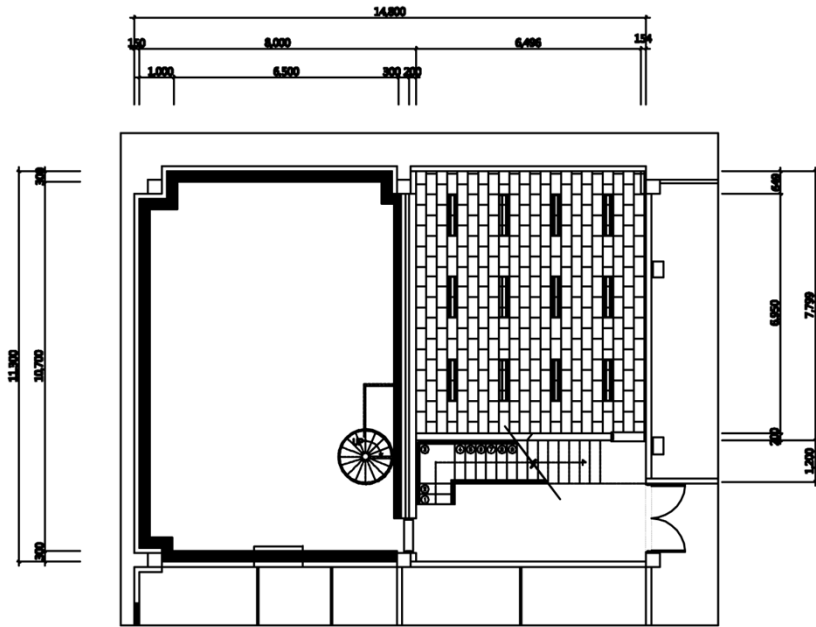

2F

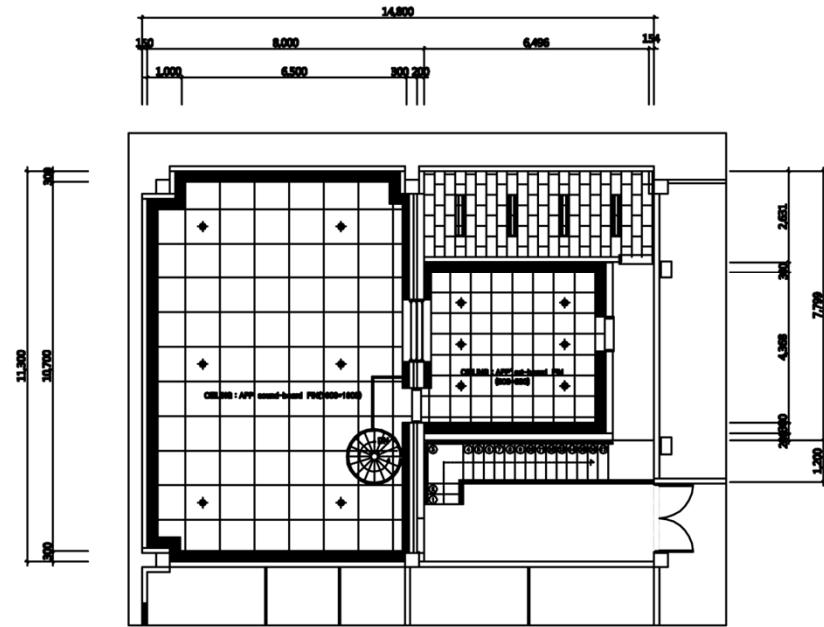

NOTE

DATE

DRAWN BY

DESIGNED BY

CHECKED BY

APPROVED BY

PROJECT TITLE

DRAWN TITLE

SCALE

SHEET NO.
DRAWN NO.

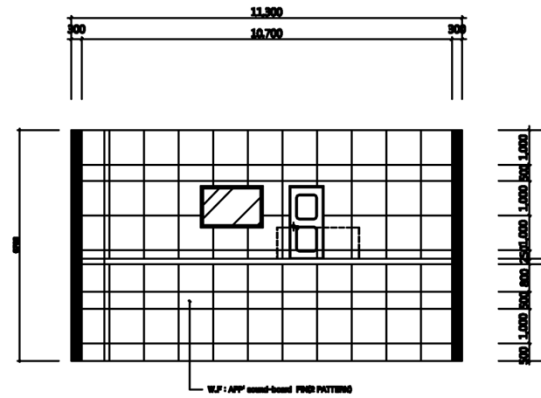
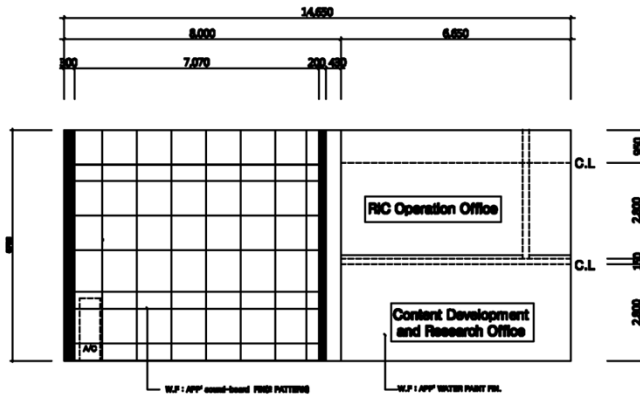

ELEVATION_A/B

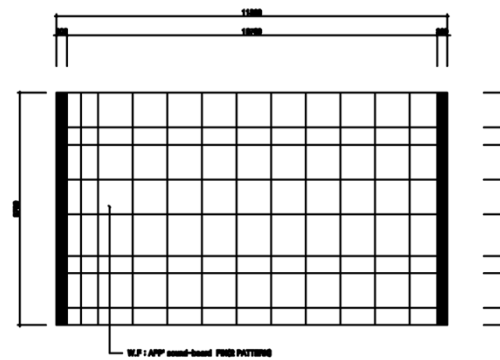
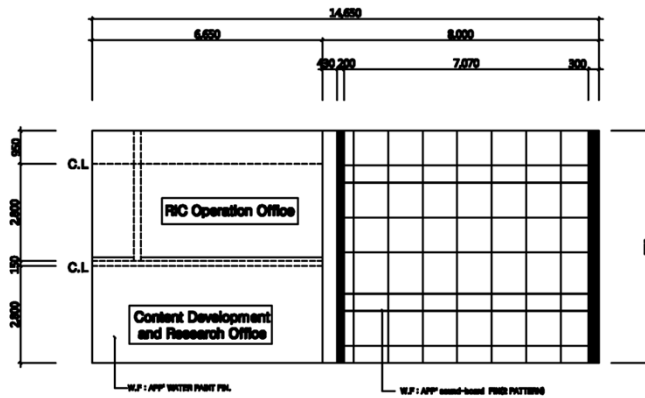

ELEVATION_C/D

NOTE

DATE

DRAWN BY

DESIGNED BY

CHECKED BY

APPROVED BY

PROJECT TITLE

DRAWN TITLE

SCALE

SHEET NO.

DRAWN NO.

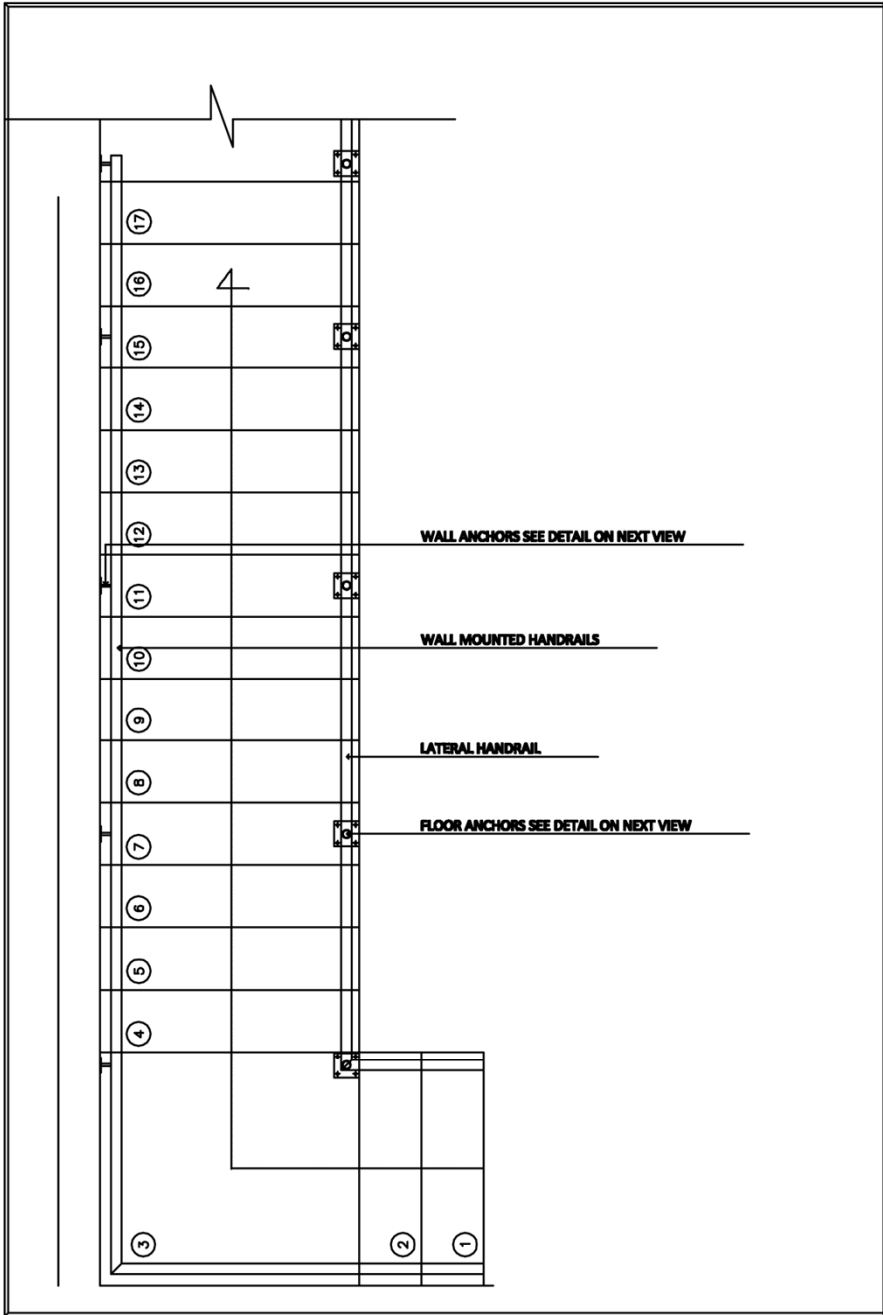

STAIR DETAILS

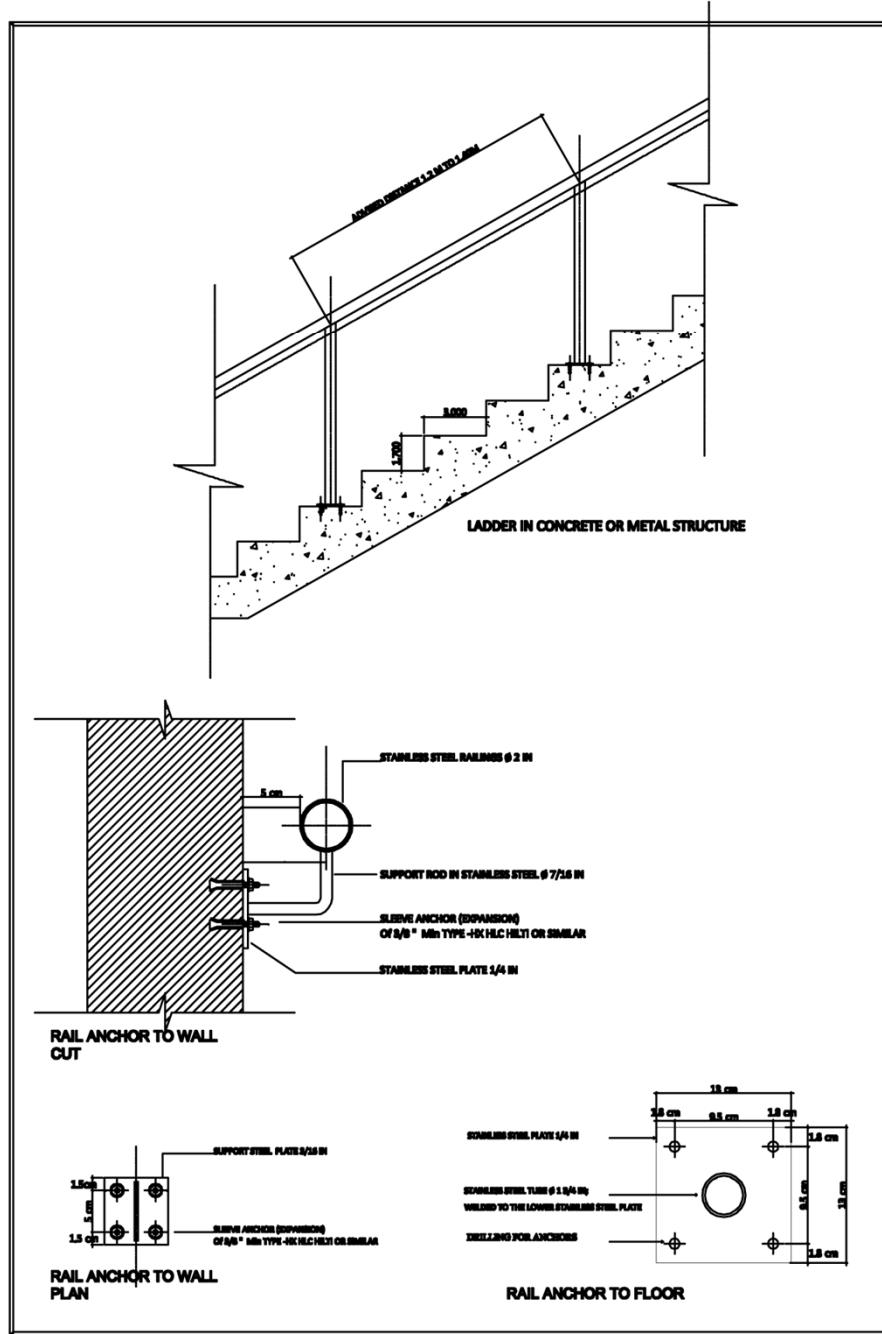

STAIR DETAILS

NOTE

DATE

DRAWN BY

DESIGNED BY

CHECKED BY

APPROVED BY

PROJECT TITLE

DRAWN TITLE

SCALE

SHEET NO.
DRAWN NO.

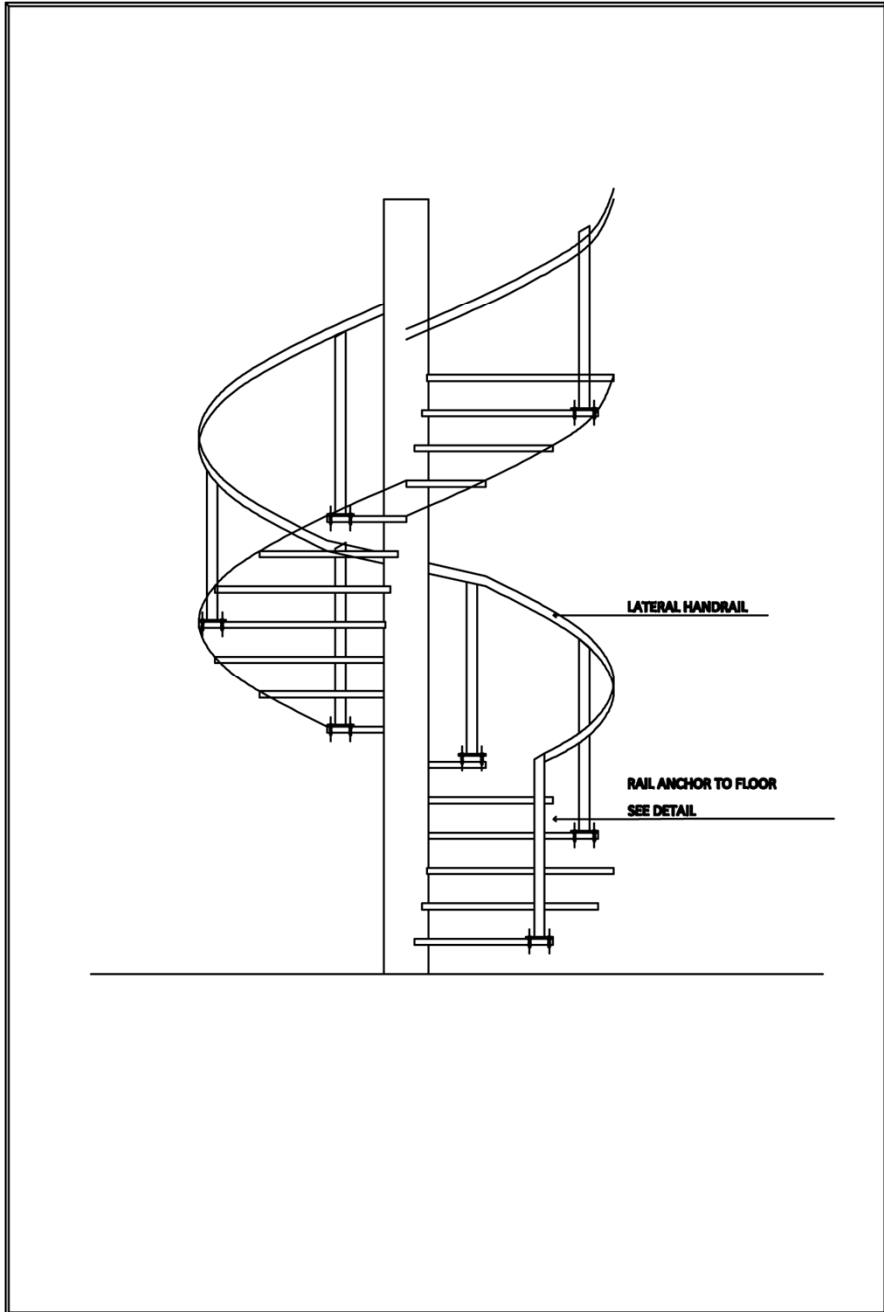

SPIRAL STAIRCASE DETAILS

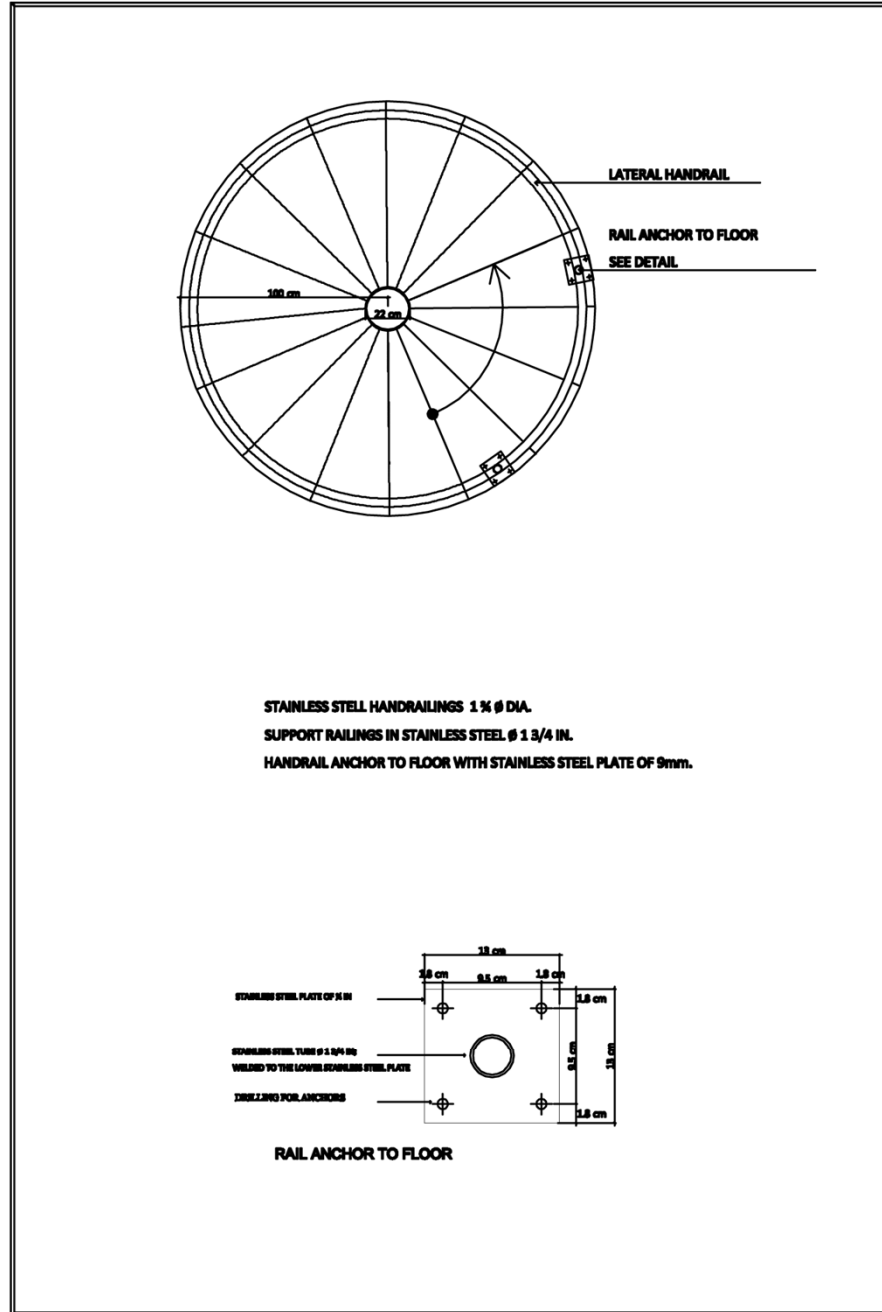

SPIRAL STAIRCASE DETAILS

NOTE

DATE

DRAWN BY

DESIGNED BY

CHECKED BY

APPROVED BY

PROJECT TITLE

DRAWN TITLE

SCALE

SHEET NO.
DRAWN NO.

CONSTRUCTION DETAILS

SCALE
1/25

1

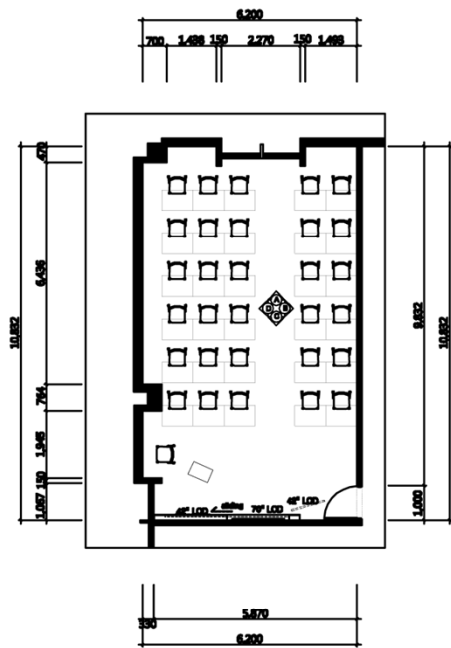

FLOOR PLAN

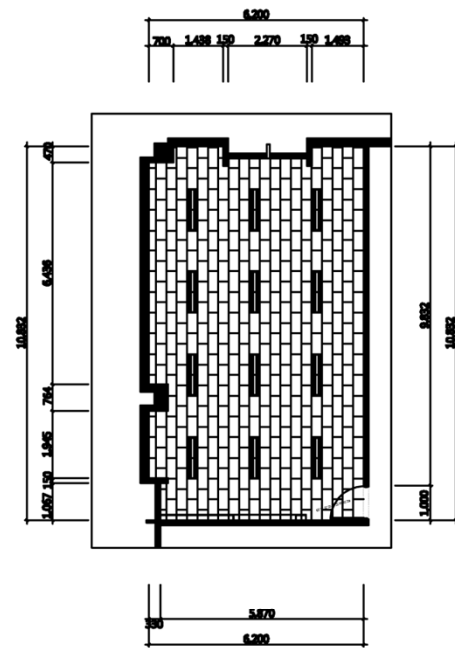

CEILING PLAN

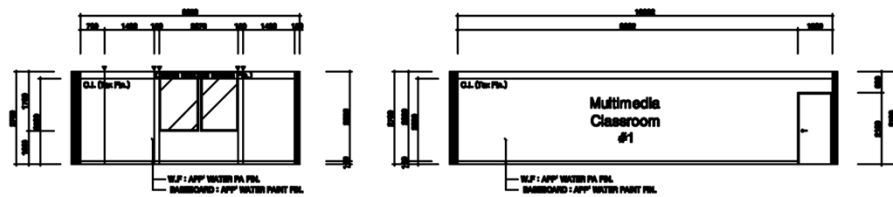

ELEVATION_A/B

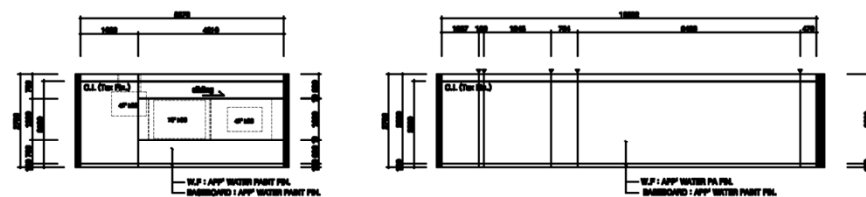

ELEVATION_C/D

NOTE

DATE

DRAWN BY

DESIGNED BY

CHECKED BY

APPROVED BY

PROJECT TITLE

DRAWN TITLE

SCALE

SHEET NO.

DRAWN NO.

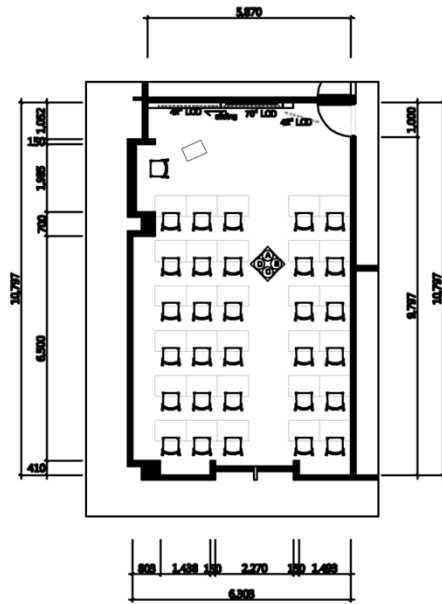

FLOOR PLAN

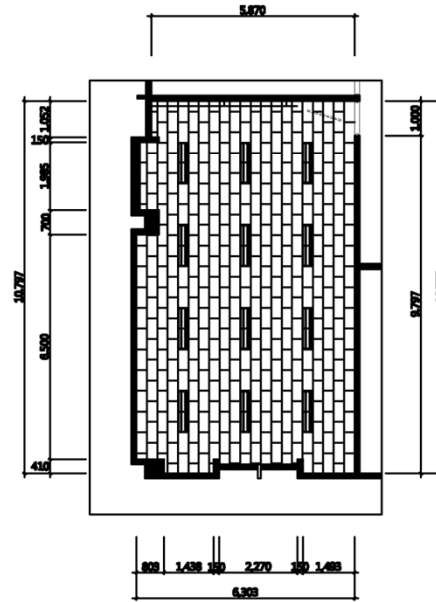

CEILING PLAN

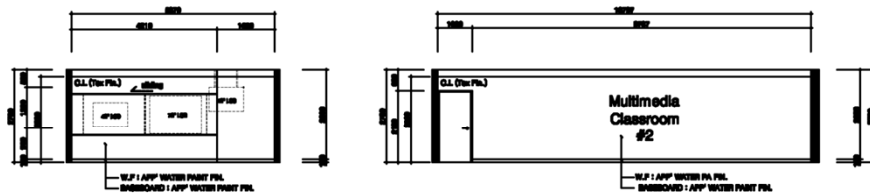

ELEVATION_A/B

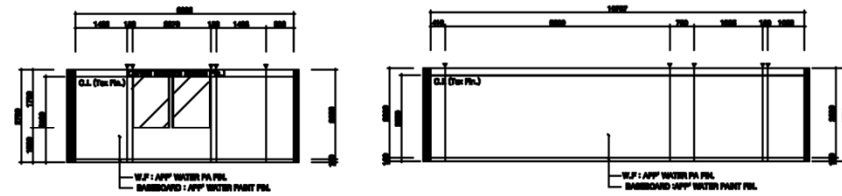

ELEVATION_C/D

NOTE

DATE

DRAWN BY

DESIGNED BY

CHECKED BY

APPROVED BY

PROJECT TITLE

DRAWN TITLE

SCALE

SHEET NO.

DRAWN NO.

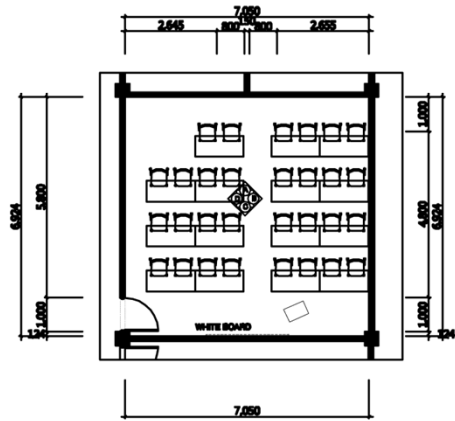

FLOOR PLAN

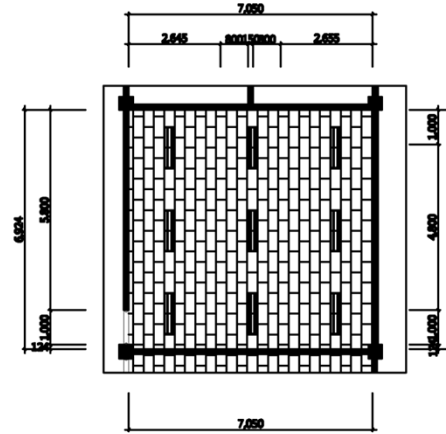

CEILING PLAN

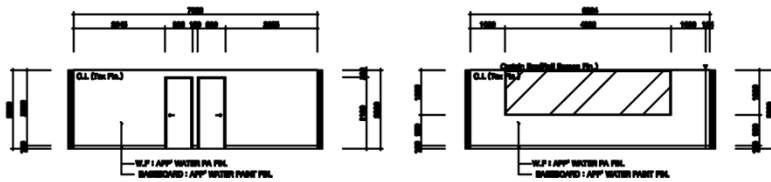

ELEVATION_A/B

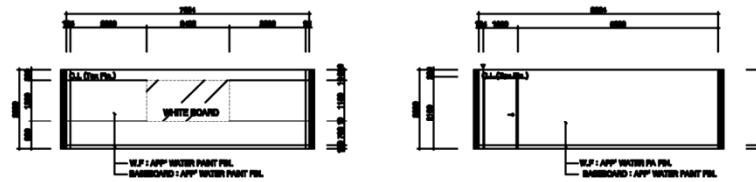

ELEVATION_C/D

NOTE

DATE

DRAWN BY

DESIGNED BY

CHECKED BY

APPROVED BY

PROJECT TITLE

DRAWN TITLE

SCALE

SHEET NO.
DRAWN NO.

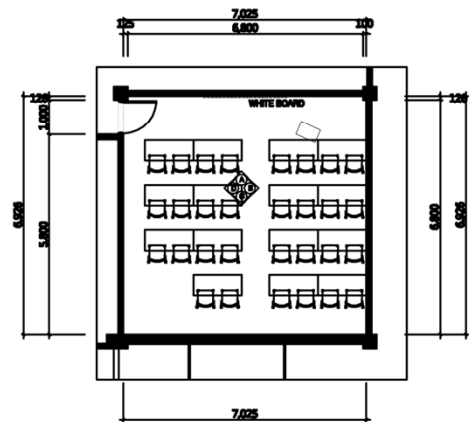

FLOOR PLAN

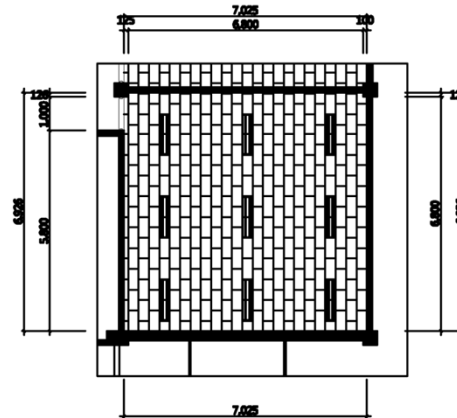

CEILING PLAN

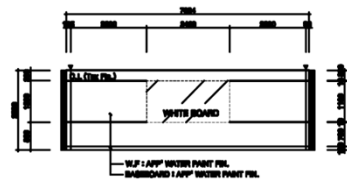

ELEVATION_A/B

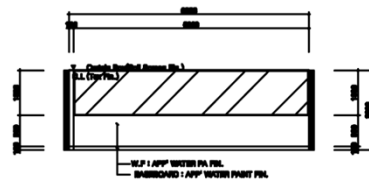

ELEVATION_C/D

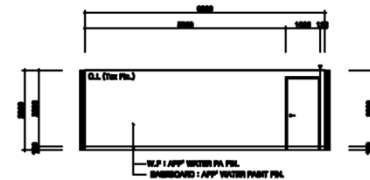
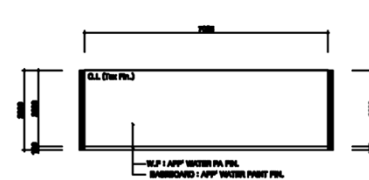

NOTE

DATE

DRAWN BY

DESIGNED BY

CHECKED BY

APPROVED BY

PROJECT TITLE

DRAWN TITLE

SCALE

SHEET NO.
DRAWN NO.

5. Alianza CIER Norte - Cartagena

* Space information of Universidad de Cartagena

RIC	Office	Building Name	Floor	Size(W X D X H)	Remark
Alianza CIER Norte (Cartagena)	RIC Operation Office	Multimedia Building	2 nd Floor	6.6 X 6.0 X 2.4	
	Multimedia Studio	Multimedia Building	4 th Floor	10 X 12 X 3.0	
	Content Development and Research Office	Multimedia Building	1 st Floor	10 X 5.5 X 2.4	
	Multimedia Classroom #1	Multimedia Building	3 rd Floor	10 X 6.0 X 2.4	
	Multimedia Classroom #2	Multimedia Building	3 rd Floor	10 X 6.0 X 2.4	
	General Classroom #1	Multimedia Building	4 th Floor	9.4 X 5.0 X 2.6	
	General Classroom #2	Multimedia Building	4 th Floor	9.4 X 5.0 X 2.6	

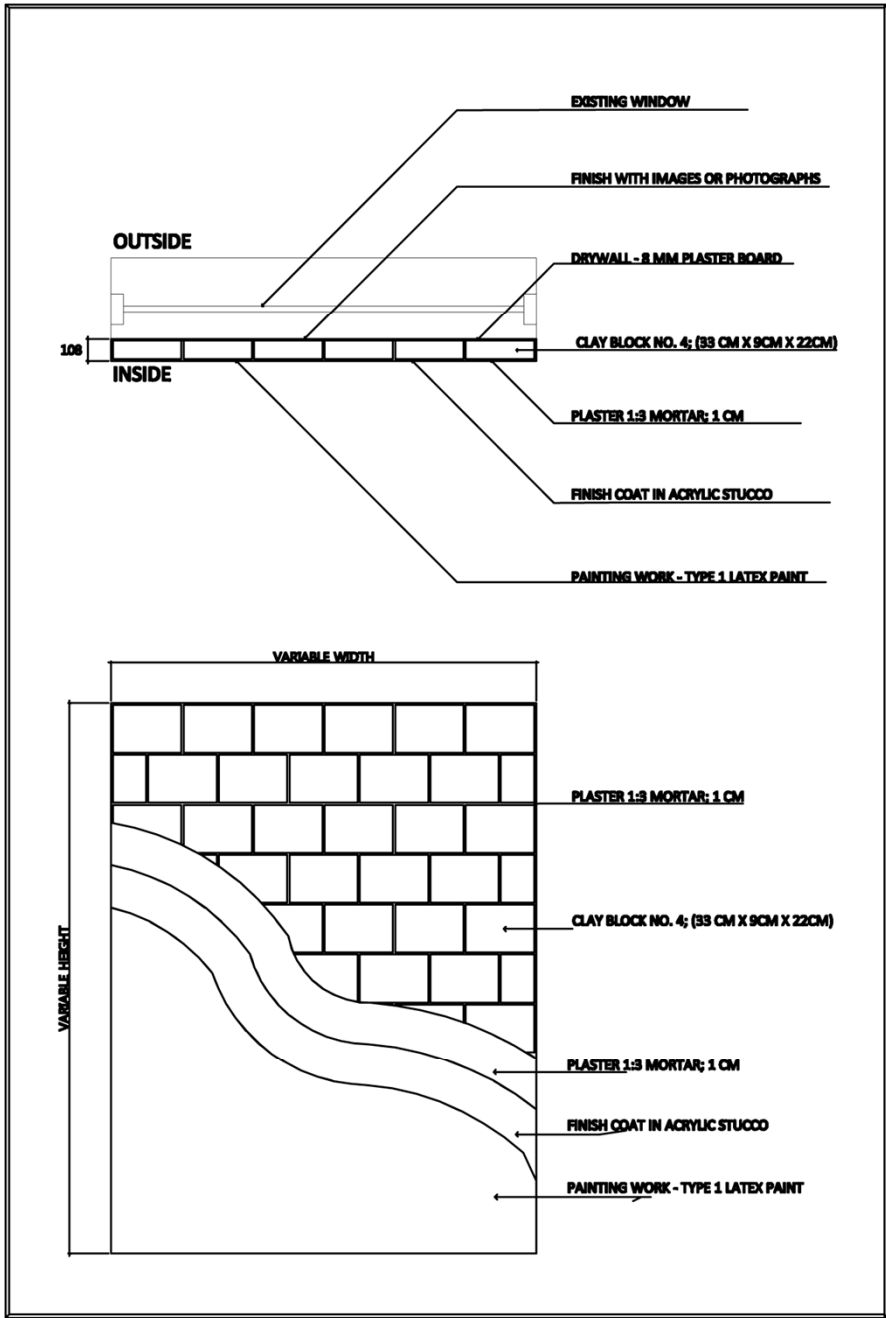

DET. 1

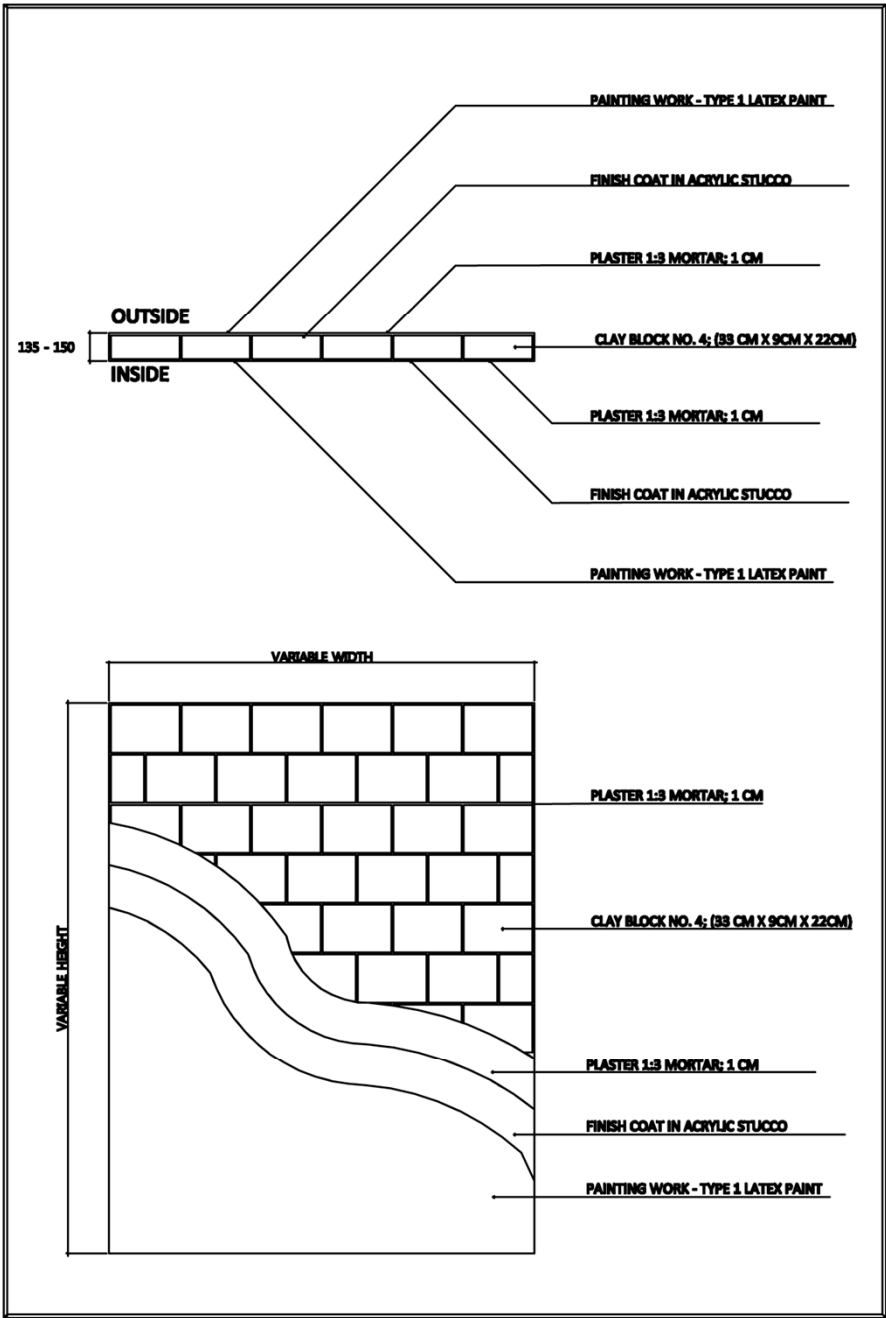

DET. 2

NOTE

DATE

DRAWN BY

DESIGNED BY

ORDERED BY

APPROVED BY

PROJECT TITLE

DRAWN TITLE

SCALE

SHEET NO.

DRAWN NO.

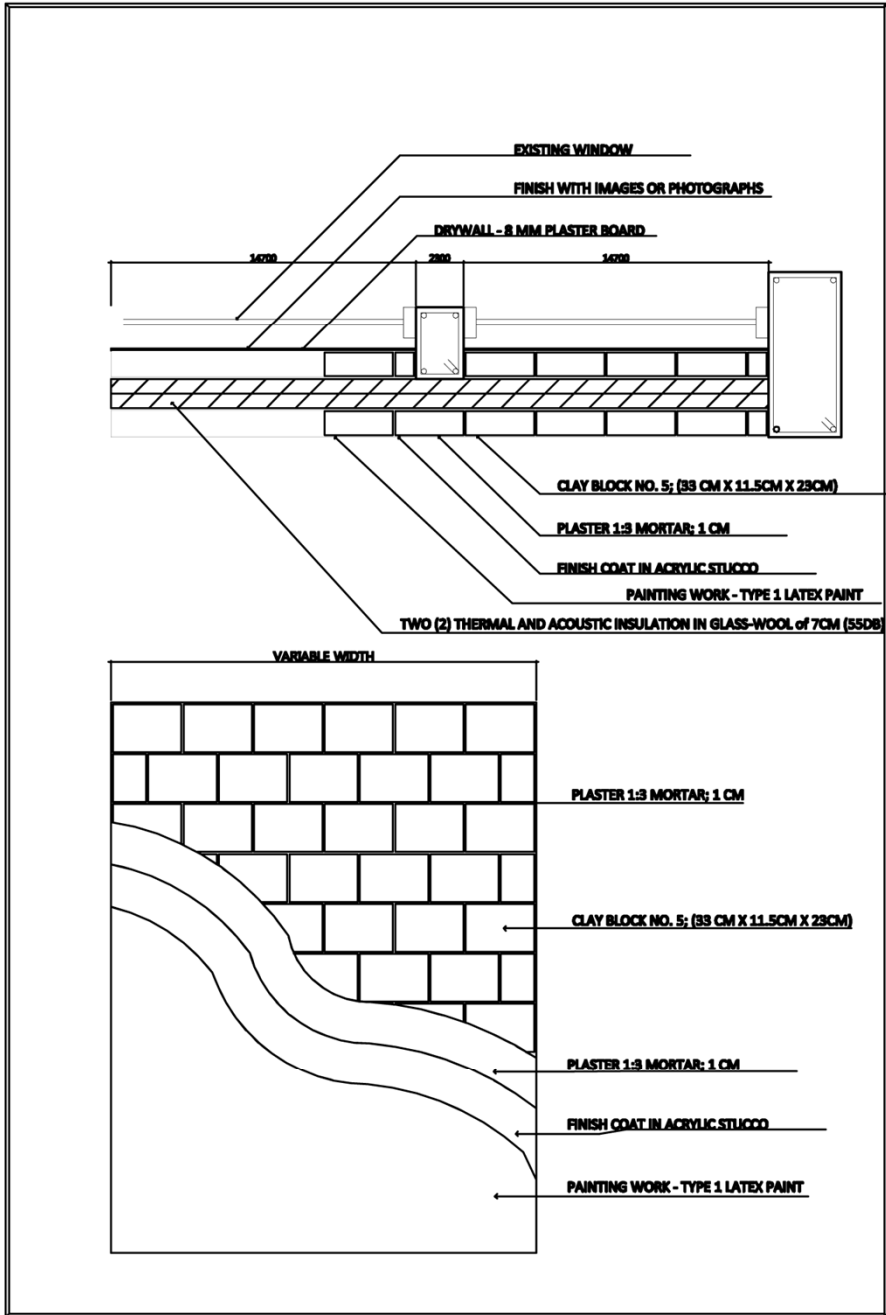

DET. 3

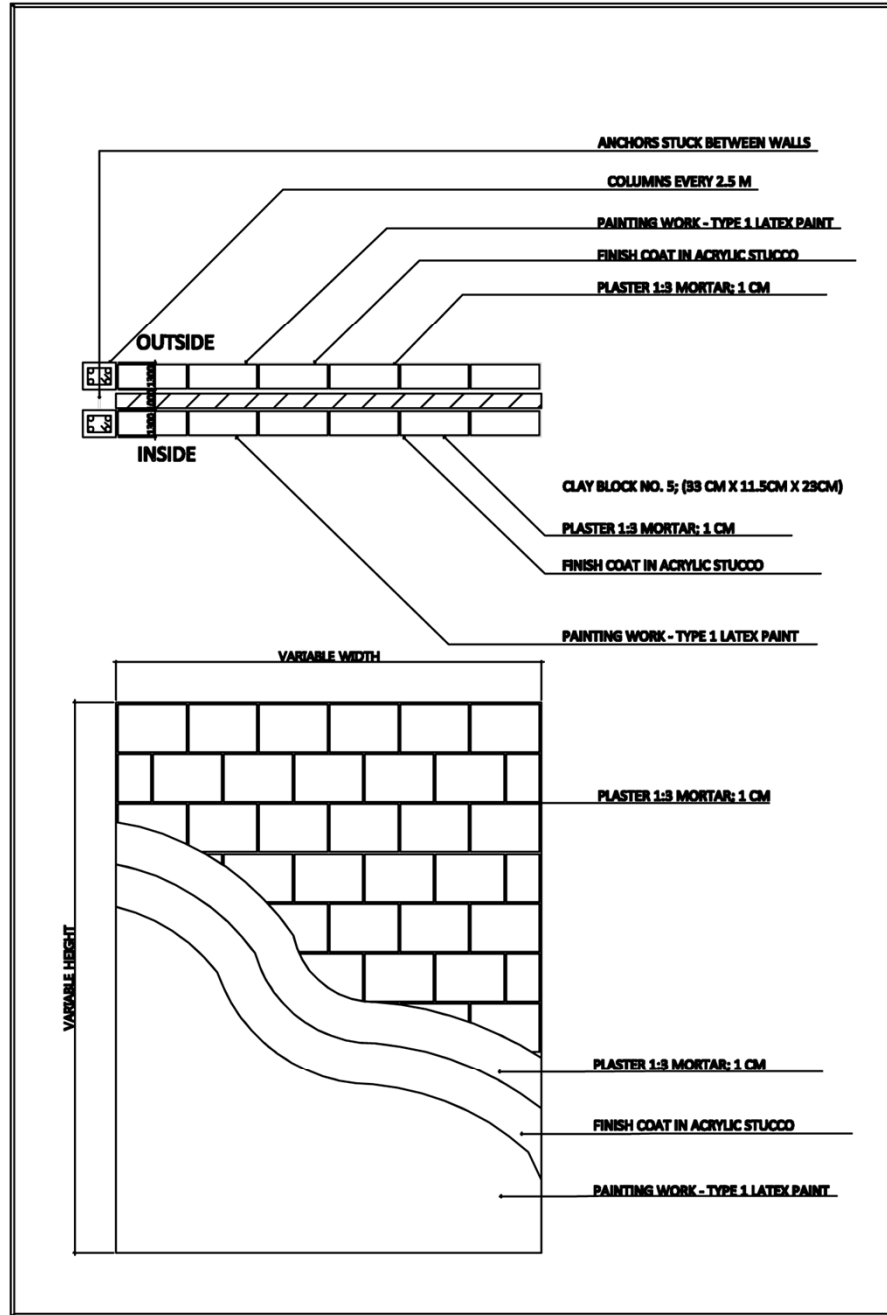

DET. 4

NOTE

DATE

DRAWN BY

DESIGNED BY

ORDERED BY

APPROVED BY

PROJECT TITLE

DRAWN TITLE

SCALE

SHEET NO.

DRAWN NO.

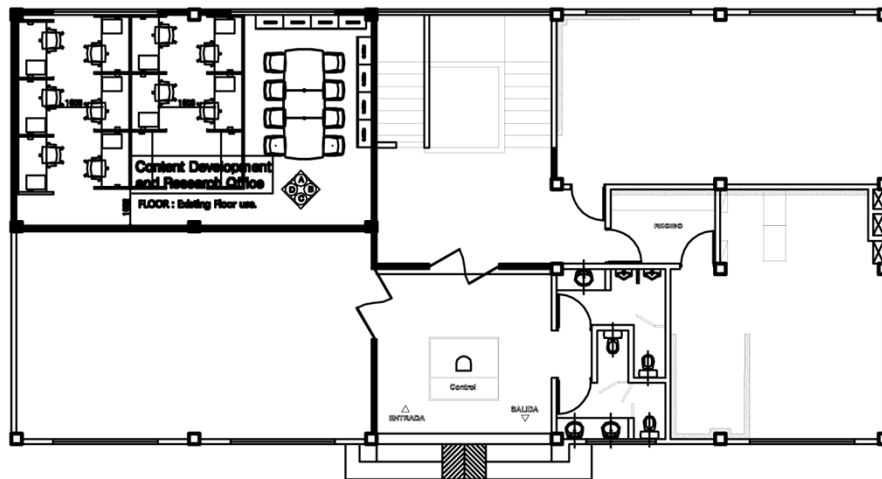

NOTE

DATE

DRAWN BY

DESIGNED BY

CHECKED BY

APPROVED BY

PROJECT TITLE

DRAWN TITLE

SCALE

SHEET NO.
DRAWN NO.

Universidad de Cartagena_1st Floor Plan for Construction

SCALE
1/150

1

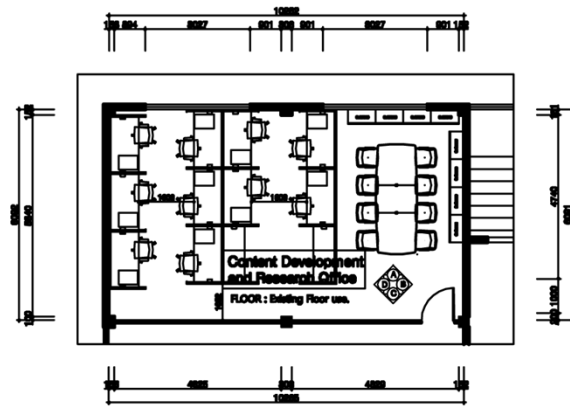

FLOOR PLAN

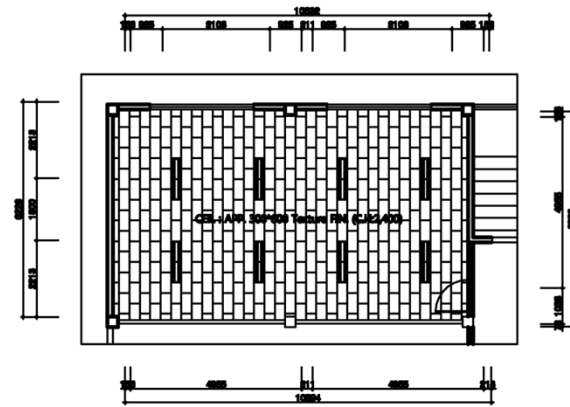

CEILING PLAN

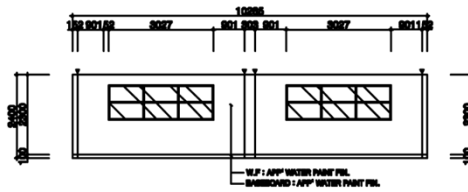

ELEVATION_A/B

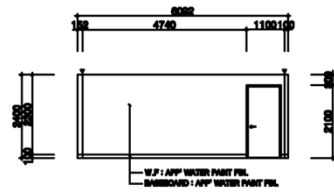

ELEVATION_C/D

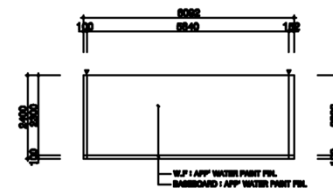
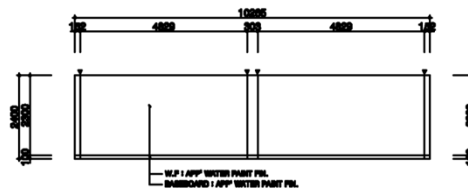

NOTE

DATE

DRAWN BY

DESIGNED BY

CHECKED BY

APPROVED BY

PROJECT TITLE

DRAWN TITLE

SCALE

SHEET NO.
DRAWN NO.

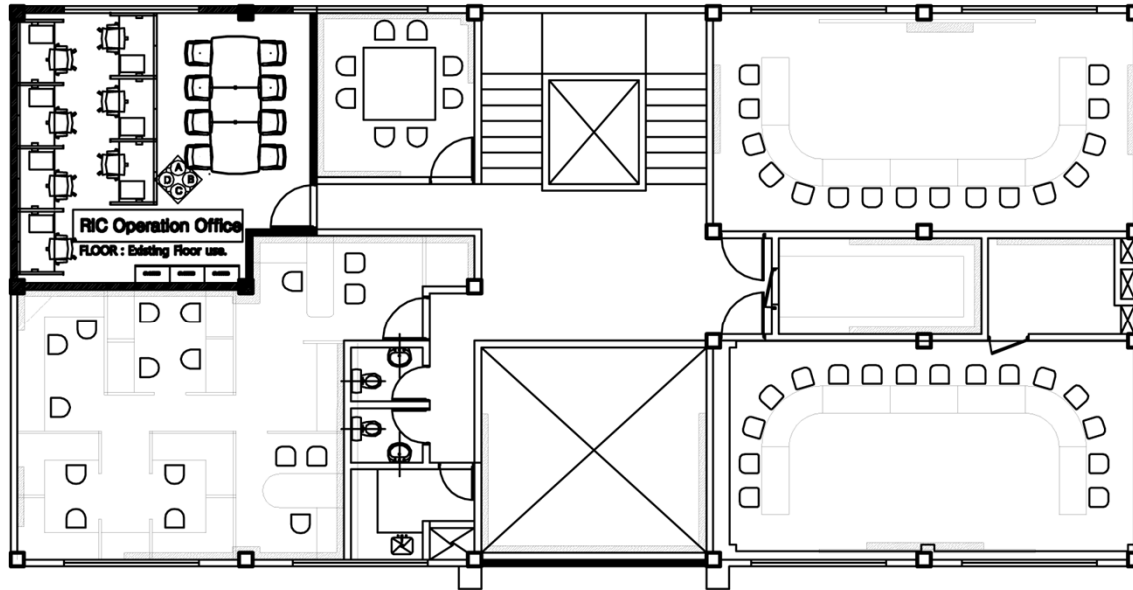

Universidad de Cartagena_2nd Floor Plan for Construction

SCALE
1/120

1

NOTE

DATE

DRAWN BY

DESIGNED BY

CHECKED BY

APPROVED BY

PROJECT TITLE

DRAWN TITLE

SCALE

SHEET NO.
DRAWN NO.

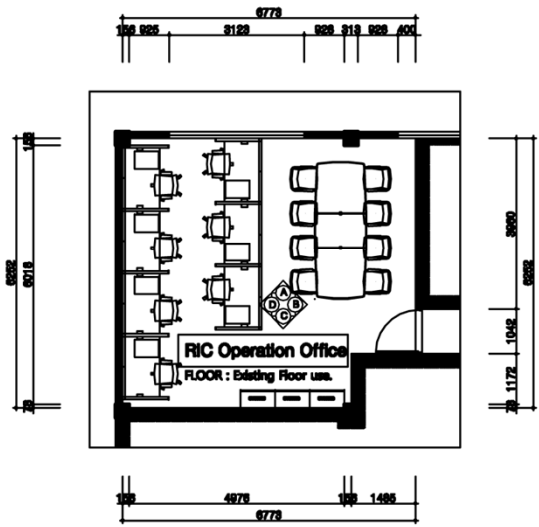

FLOOR PLAN

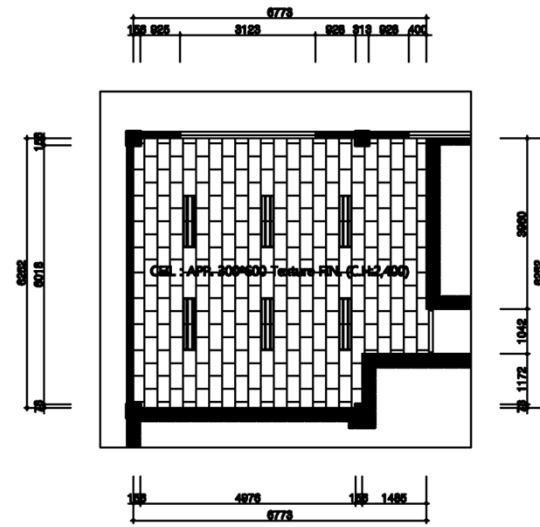

CEILING PLAN

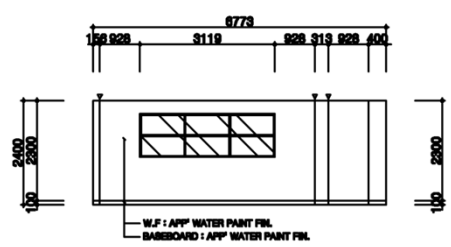

ELEVATION_C/D

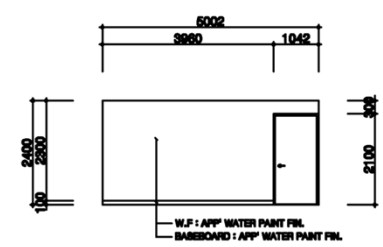

ELEVATION_A/B

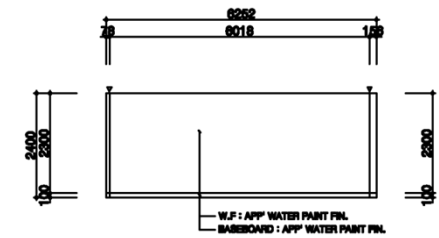
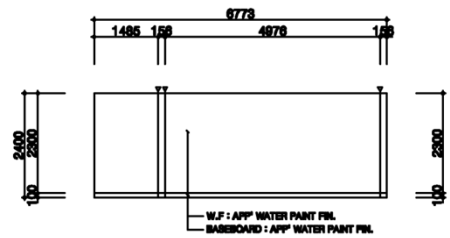

NOTE

DATE

DRAWN BY

DESIGNED BY

CHECKED BY

APPROVED BY

PROJECT TITLE

DRAWN TITLE

SCALE

SHEET NO.
DRAWN NO.

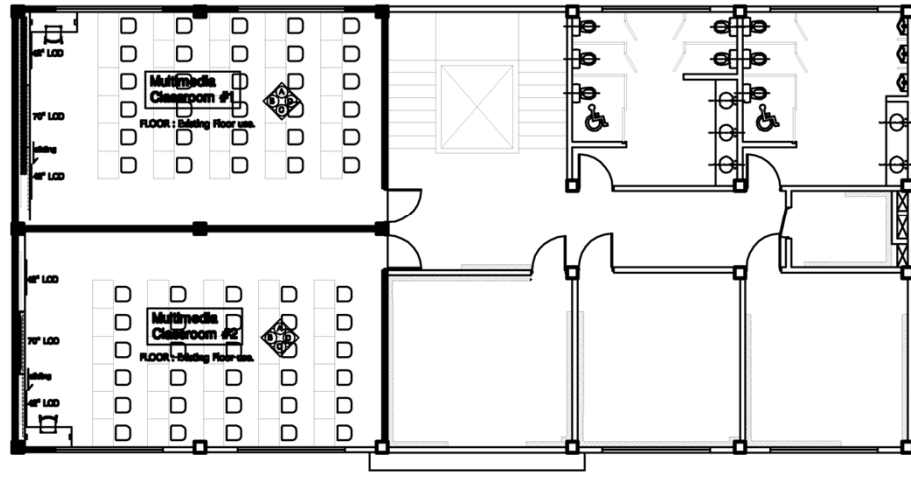

NOTE

DATE

DRAWN BY

DESIGNED BY

CHECKED BY

APPROVED BY

PROJECT TITLE

DRAWN TITLE

SCALE

SHEET NO.
DRAWN NO.

Universidad de Cartagena_3rd Floor Plan for Construction

SCALE
1/150

1

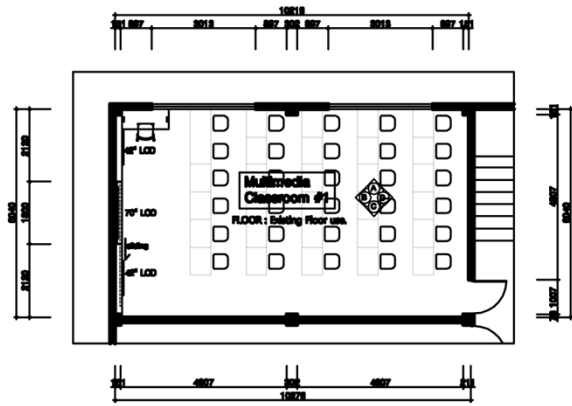

FLOOR PLAN

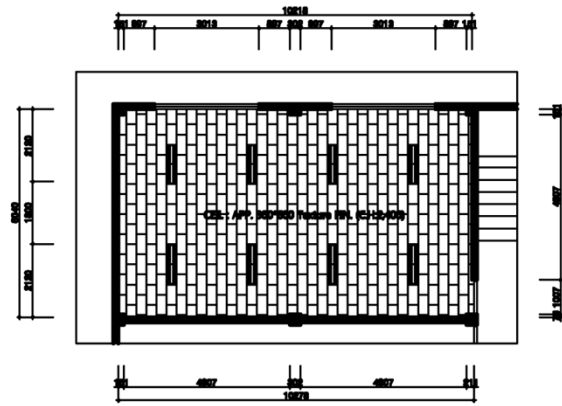

CEILING PLAN

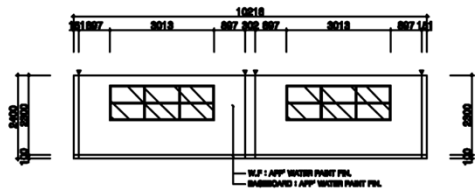

ELEVATION_C/D

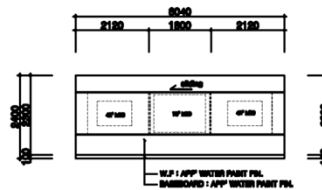

ELEVATION_A/B

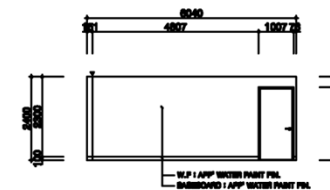
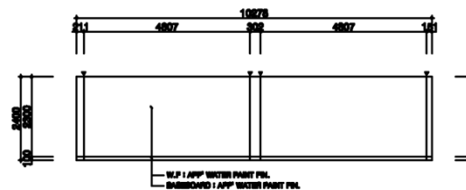

NOTE

DATE

DRAWN BY

DESIGNED BY

CHECKED BY

APPROVED BY

PROJECT TITLE

DRAWN TITLE

SCALE

SHEET NO.
DRAWN NO.

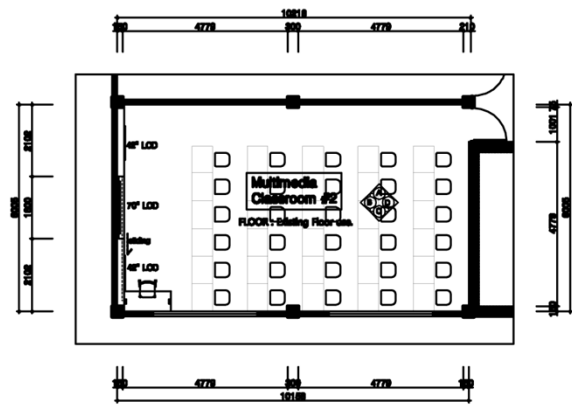

FLOOR PLAN

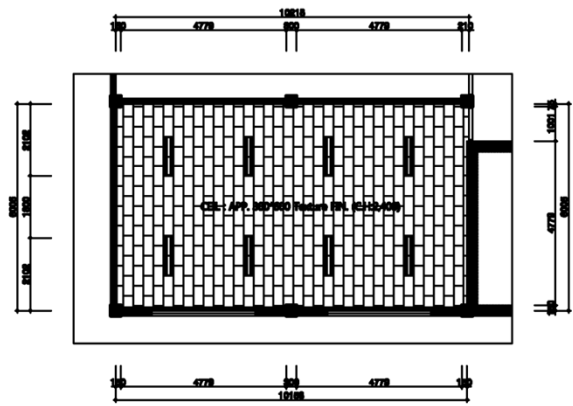

CEILING PLAN

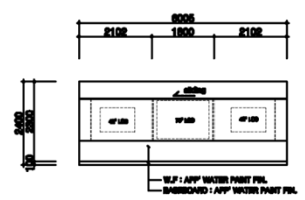
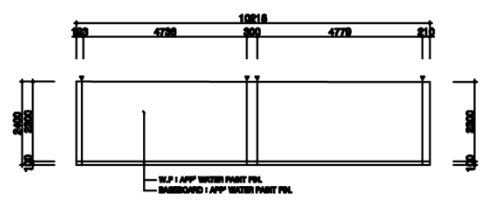

ELEVATION_A/B

ELEVATION_C/D

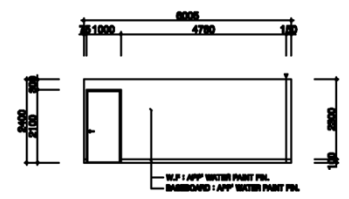
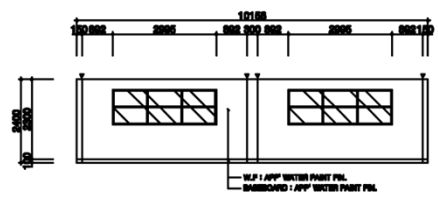

NOTE

DATE

DRAWN BY

DESIGNED BY

CHECKED BY

APPROVED BY

PROJECT TITLE

DRAWN TITLE

SCALE

SCALE
1/150

1

SHEET NO.
DRAWN NO.

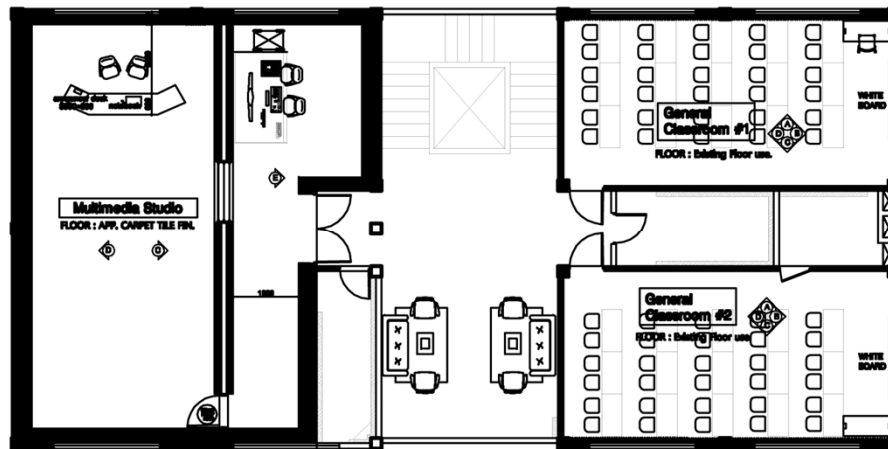

NOTE

DATE

DRAWN BY

DESIGNED BY

CHECKED BY

APPROVED BY

PROJECT TITLE

DRAWN TITLE

SCALE

SHEET NO.
DRAWN NO.

Universidad de Cartagena_4th Floor Plan for Construction

SCALE
1/150

1

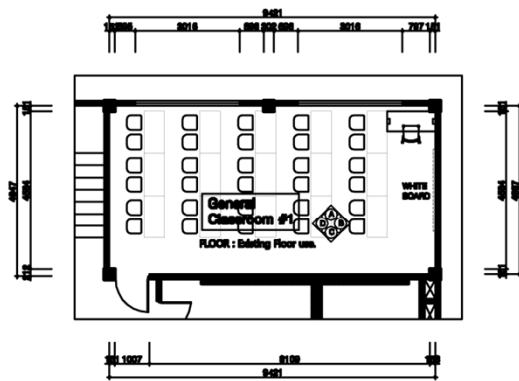

FLOOR PLAN

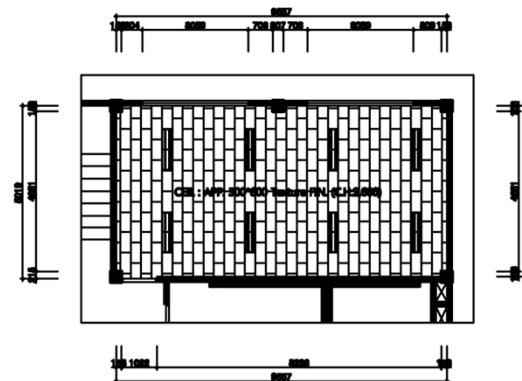

CEILING PLAN

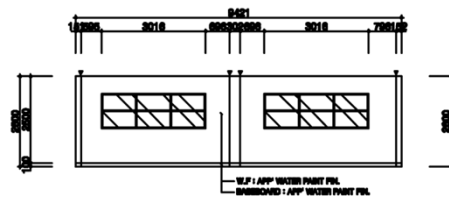

ELEVATION_C/D

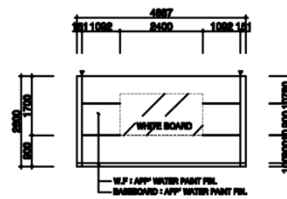

ELEVATION_A/B

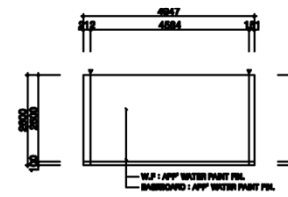
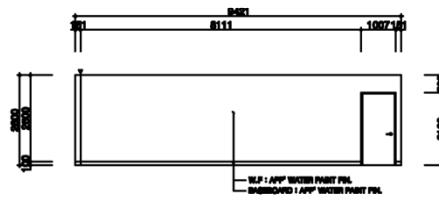

NOTE

DATE

DRAWN BY

DESIGNED BY

CHECKED BY

APPROVED BY

PROJECT TITLE

DRAWN TITLE

SCALE

SHEET NO.

DRAWN NO.

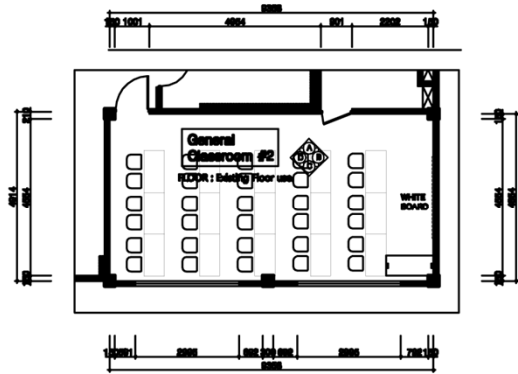

FLOOR PLAN

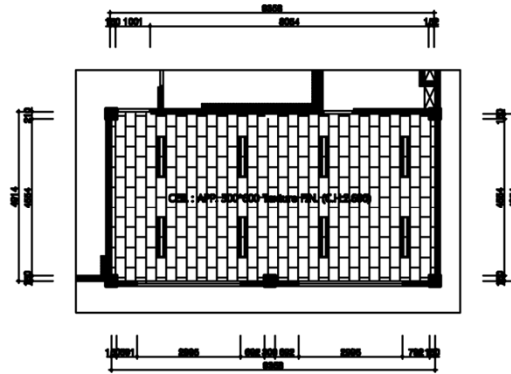

CEILING PLAN

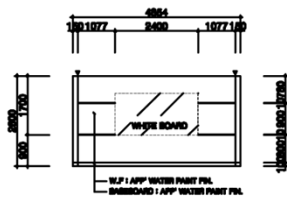
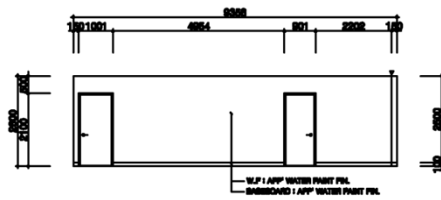

ELEVATION_A/B

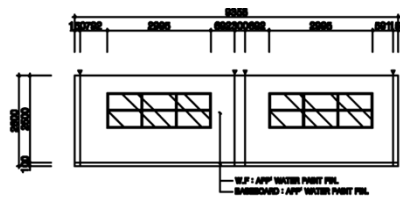

ELEVATION_C/D

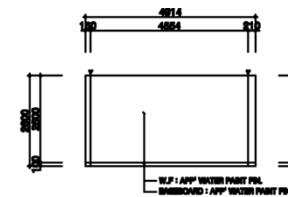

NOTE

DATE

DRAWN BY

DESIGNED BY

CHECKED BY

APPROVED BY

PROJECT TITLE

DRAWN TITLE

SCALE

SCALE
1/150

1

SHEET NO.
DRAWN NO.

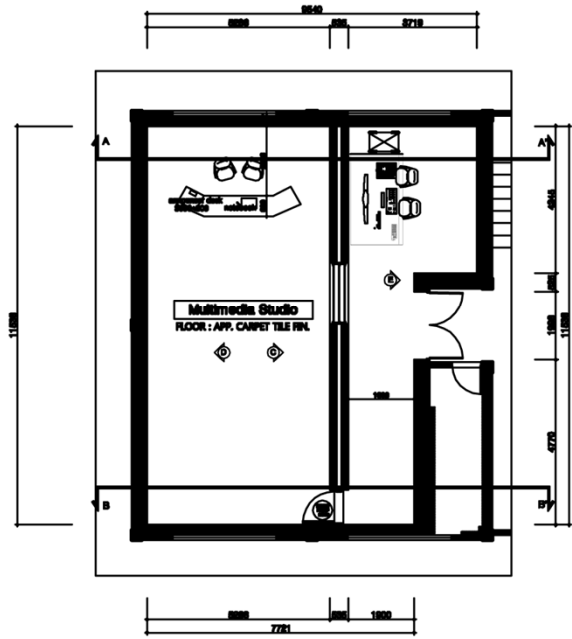

FLOOR PLAN

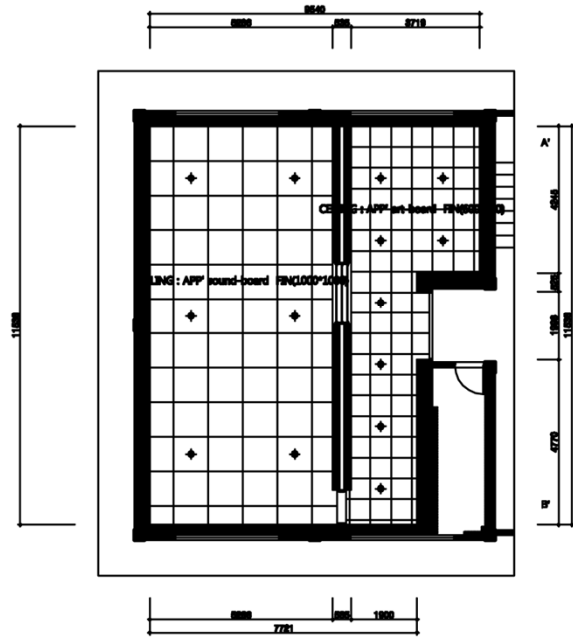

CEILING PLAN

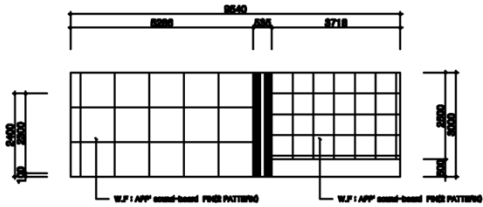

ELEVATION_A-A'

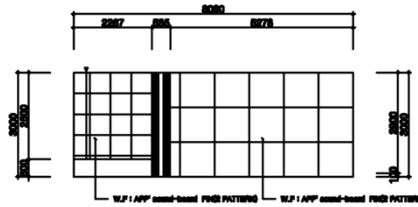

ELEVATION_B-B'

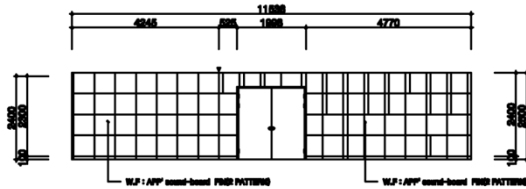

ELEVATION_C

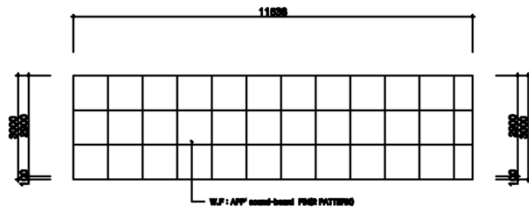

ELEVATION_D

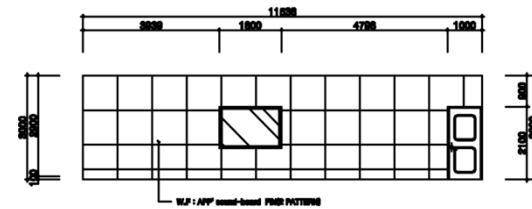

ELEVATION_E

NOTE

DATE

DRAWN BY

DESIGNED BY

CHECKED BY

APPROVED BY

PROJECT TITLE

DRAWN TITLE

SCALE

SHEET NO.
DRAWN NO.